

# 1st Rigger Helmet

Redefining Safety & Unmatched Protection



Rigger's magazine 2023



**Highlights of brands**  
**New & Innovative products**  
**Stunning projects**  
**Interviews**  
**Interesting articles**  
**Technical topics**  
**And other topics curated for riggers.**

Brought to you by





RIKIE LOVES YOU.

RIKIE CROSS

WARTTE CROSS

BIZKATTE  
HET LEVEN IS EEN GROOT FEEST!

TM<sup>4</sup>

LITEC<sup>4</sup>

TOMCAT<sup>4</sup>

JTE<sup>4</sup>

PROLYTE<sup>4</sup>

EXE<sup>4</sup>  
TECHNOLOGY

flexa<sup>4</sup>  
TEAMWORK

Xstage<sup>4</sup>

Xtruss<sup>4</sup>

Xlift<sup>4</sup>

STAGEDEX<sup>4</sup>

PROLYFT<sup>4</sup>



## Content:

Interview with our CEO	4
Rigging Commandos	8
Inside the company: People	10
<b>MILOS</b>	<b>16</b>
• Steel truss project	18
• Interview with Sales Manager	19
• A blood rigging guide	20
• Product highlights	22
• Quality ingredients essentials	26
<b>LITEC</b>	<b>28</b>
• Interview with Product Strategist	30
• Designing according to UX/UI protocols	31
• Towns on the laguna	32
• Product highlights	34
<b>XLIFT</b>	<b>38</b>
Merchandise	41
How do the maps lie?	42
<b>PROLYTE</b>	<b>44</b>
• Interview with Projects Director	46
• New projects	47
• Partnership what matters	48
• A Marketplace that shock the eyes	50
• Product Highlights	52
<b>TOMCAT</b>	<b>54</b>
• Interview with president and CEO	56
• Tomcat U	57
• Knox whiskey works	58
• Product Highlights	60
• Barkleys marathon	62
<b>EXE TECHNOLOGY</b>	<b>66</b>
• Interview with Brand Manager	68
• Friction or no friction. That Is the question!	70
• Product highlights	72
• Brave New World of Robots	76
<b>FLEXA SENSORS</b>	<b>78</b>
• Interview with Brand Manager	80
• Hooked on Shackles	82
• Product Higlights	84
<b>Powder Coating Explained</b>	<b>86</b>
A4I.tv	88
The Deadline Hunter	90

Text by Pavel Vondráček • Photo by Dan Vojtěch

# I Am Not a Robot. I Have Responsibility.

František Zykan, head of Area Four Industries, explains why a robot never will never fully replace humans, why he sees a bright future for his company, what the differences are between employees in Europe, Asia and the USA, and why the welder of space structures has a clear head after his work.

**You have purchased your first welding robot for your company. Is it to replace human labour?**

The word robot comes from the Czech language, my native language, where “robot” in the vernacular means hard work. The robot does it for us, welding structures. But it will never replace man, only supplement him.

**How big progress is this for the company?**

Structural engineering is a conservative industry, and the word progress is not a common one. If something works well and is safe, there is no reason to change the work mechanism. If I ask if any modern painter is better than Leonardo da Vinci just because he has better painting techniques, then I have to say no. So a robot may partly speed up the work of welding, but its programming is done by a human being, its control is done by a human being, and, moreover, it needs its human operator.

**Can a robot and a human inspire or help each other?**

Yes, but it’s a one-way street. Robot doesn’t consciously take anything from a human because a robot has no intelligence. But humans can take inspiration from the robot’s ability to switch off. That’s an important feature. You can reboot, reconfigure, upgrade, shut down the robot to increase its performance. Unfortunately, that’s not possible with the human brain. Everything we see, read and perceive is permanently stored in our heads. But while the computer has an “empty the bin” function, preventing the system from being overburdened, the human brain does not. Today’s man, unlike the robot, cannot switch off and has lost the ability to rest.

**And isn’t this why many people today are returning to manual work?**

Yes, neurologists confirm that. To work effectively, the brain has to be bored on a regular basis — i.e. not doing anything, not reading, not watching, not communicating, just lounging around. We can see this in children who have not lost this ability — sometimes, they would just sit and stare into space. But this is an important point because when a person is bored, their brain processes information. Maybe that’s the reason why so many of our welders are so intelligent people, people who with their abilities stand head and shoulders above a lot of corporate managers.

**Can you elaborate on that?**

Truly intelligent persons are to some extent selfish and think of themselves, because only then can they benefit their environment. A stressed-out and tired person does not help anything. In our country, a worker comes to the factory in the morning, works manually and then, unlike me, who spends all day at his desk, does not have to go to the gym in the evening. In the early afternoon, after eight hours of decently paid work, the welder goes home with a perfectly clear head. He’s not stressed, he doesn’t bring work problems home, so he can focus on his family, his interests and his education. In terms of quality of life, the worker at Area Four Industries is perhaps better off than I am, who is constantly worried and thinks about the company even in his sleep.

**Do you want to change with them? You weld the structures, and they’ll relieve you in the office for management work.**

Unfortunately, I can’t because we have many welding booths and too few offices. In fact, I am proud of the fact that we are a global company with a significant market share in our industry, but we have not yet been eaten by the bureaucratic worm, nor have we been largely attacked by the home office disease!

**Why? Remote working is a wonderful invention.**

Yes, for employees, but not for employers. The reason why our company is successful, why we avoid turbulences, is precisely because we are truly a physical company. We don’t build castles in Spain, we don’t sell illusions, and we make tangible things out of aluminium and steel. You can’t make those in a home office somewhere. But even those employees who could theoretically work at home, come to work, and they like it. Because humans are evolutionarily wired to socialize and deal with a larger group of people, to solve problems with them, to brainstorm ideas, to respond immediately to complications or opportunities. Working from home does not allow this in principle. I observe this and many of my friends in companies whose employees work from home. What were once executive and creative managers have become telephonic operators whose rhythm of life is determined by their employees. This is very destructive for business.

**You don't use communication programmes?**

We do and we have to. We have factories not only in the Czech Republic but also in Italy, China, USA and sales offices all over the world. Although internet communication helps a lot, I am often on a plane because you cannot run a company from virtual space, unless you want to turn it into a classic bureaucratic corporation. I prefer face-to-face meetings. And not only do I have to, but I also want to. It's the essence of our business, after all, we make stages and podiums for physical entertainment, not for that illusory world where you put on a pair of goggles and find yourself in virtual reality. Every action provokes a reaction and we don't see a drop in customers after the covid epidemic, nor do we see a trend of people not wanting to physically meet. Quite the opposite. The reaction to the combination of covid lockdown and home office work has created a need for people to physically meet each other, to go to concerts together, to parties, to the theatre, just anywhere they need our stage. I myself was surprised at how the global market for physical entertainment has taken off.

**One of your slogans is "all the world is a stage, and we make this stage".**

This slogan works but only in English speaking world. It is based on William Shakespeare's play *As You Like It*. The melancholy hero Jaques says in the second act that "All the world's a stage", and compares the world to a stage and life to a play. For a person educated and raised in an Anglophone country, this is a perfectly understandable phrase, but it doesn't work in, for example, Germany or here in Czechia. In Czech we have a different phrase: "The planks that mean the world." But what is meant are the theatre boards that once made up the floor of the theatre stage, figuratively the theatre as such, and indeed the whole world. The sentence "Bret ter, die die Welt bedeuten" comes from the pen of the German playwright and poet Friedrich Schiller, namely from his poem *An die Freunde*. So we are actually using two slogans. We use it as a way of saying that there is still no global world and no global culture and that, fortunately, the world is still extremely diverse.

**Music, theatre, and entertainment are different in different countries, but the stages are the same. Isn't there a difference between them?**

Stages are the same in principle, only in America, steel is used more, while in Europe, with its emphasis on lightness and ecology,

lightweight aluminium prevails. The differences, however, are in the workload and in the attitude towards employees. You have to treat a Chinese or Vietnamese welder differently from a Czech or Italian welder. A worker in Asia learns a part of the production process perfectly and is then happy to do it all his life. The European worker is a little different, when he knows something perfectly, he gets bored and wants to learn something else. A good company understands these cultural differences and distributes work and pay accordingly.

**Can you give a particular example?**

Like the start of work hours. In the Czech Republic, it is common to start work in factories as early as six o'clock in the morning. This is typical for the whole of Central Europe, and according to some historians, it is a remnant of the Austro-Hungarian monarchy, of which the Czech lands were a part until 1918. Emperor Franz Joseph I was known for getting up very early, before 5 a.m., and after hygiene, church service and breakfast, he regularly sat at his desk after 7 a.m. and received reports from the whole empire. It would have been a disgrace to get up at a time when the Emperor was already at work, and so the wheels of the whole monarchy were turning as early as six o'clock in the morning. It may be only a legend, but there is no power or will to change this setup today. The Czechs want to be home by 2:30, to spend time with family, shopping and themselves. A welder in Italy, for example, would not agree to such a thing.

**Czech Republic has one of the lowest unemployment rates in Europe? Are you successful in recruiting employees?**

It's difficult. But the reason isn't that they don't get enough money with us, rather the contrary, we are above average, but it has to do with another specificity of Central Europe. Czechs are not willing to move for work or commute for long periods of time. More than half of Czechs would not move for a job, even if it meant they would be out of work. The majority would not want to lose more than 30 to 60 minutes commuting to work. Surveys show that a quarter of Czechs are willing to commute no more than ten kilometres for work, half up to 40 kilometres and only a quarter more than 50 kilometres.

Proximity to the place of work is the second most important criterion for Czechs' decision-making. However, the amount of pay comes first. Unlike China, the USA or Italy, we are quite limited in our choice, but if we have such a worker, he or she will be loyal to the company for life.

**A few years ago, the whole world was impacted by covid, 2022 and 2023 are marked by the war in Ukraine. Does this have an impact on you?**

Of course, there's been a disruption in the delivery-supply chains. A large part of the "aluminium world" that makes up our constructions comes from Ukraine. It was a big logistical challenge, but our managers coped perfectly. But the conflict affected not only trade but also production. Before the war, Ukrainian men made up quite a large part of the workforce in the Czech Republic. Some returned home and enlisted in the army.

**I was intrigued by your idea that the robot is actually stupid because it doesn't have its own intelligence. What do you think of AI, which is all the rage now?**

That the robot is stupid is not my idea, it's just a fact. And artificial intelligence is seen as intelligence only by journalists. They are very sophisticated programs, and they can certainly help people, but they have no consciousness of their own, they cannot make their own decisions, and they still use human creativity.

**Have you tried any of the "artificial intelligence" programs, for example in marketing or promotion of your company?**

Yes, but it's still not what we want. Illustrator programs are very effective, and they help artists, but they certainly don't replace them. It's the same with writing advertising copy for our publications or social networks. It's good, but you still feel that it's not right, that it lacks human soul. I'm not a pathetic person, but that statement is accurate. For example, when we needed to create imagery to accompany our recruitment adverts, we were deciding between the work of a photographer and the work of a high-end program. But there is still no substitute for human work and imagination. I would compare the result of computer and human work to the difference between food prepared at home and from a fast food restaurant. And as long as we can, we will make all marketing and promotional stuff in-house.

**Do you see yourself as a macro or micro manager?**

I have to manage both. Sometimes it happens that I have an important customer from the USA on the phone, we are dealing with a really big delivery of our products and I look out the window and see that the warning beacon on the entrance barrier at our factory in Roudnice, Czech Republic, does not work again. At that moment, I would like to put the phone down and call



## Management of Czech team

the maintenance team to fix it immediately. Fortunately, I can still distinguish between what is essential and what is not.

**All your products bear a small label with a code and mandatory information. But in addition, there is always the name of the welder - e.g. Šimo. Why is that?**

Because in today's anonymized age, it is extremely important that customers and especially riggers know that each specific piece was made by a specific person. And that person is responsible.

**But now you have the first robots in the factory. Do they have their name on the label, too?**

Behind each robot is an operator who controls his robot. So his name will be there. Because the robot doesn't realize the responsibility.

**Does your business have a future?**

And a big one. All over the world, the amount of time people spend working is decreasing. There's a glut of free time and people want to enjoy themselves. They're partly attracted to virtual reality, but physical encounters are natural. That's why I think the production of structures for the entertainment industry is poised for a big boom. And I recognize this in my own life — I wanted to buy a ticket to see Bruce Springsteen, who is now on a European

tour. And I couldn't get a single ticket to any of his 30 concerts. All are absolutely sold out, including the most expensive tickets. And so I won't be seeing Bruce on any of our stages.

**What has upset you the most lately?**

The behaviour of some creatives from advertising agencies. The robot can't turn itself off, but these artists can't turn themselves on.

A good company understands the cultural differences of its employees and organises working hours accordingly.



# Rigging Commandos

**We would like to introduce the Rigging Commandos, an elite rigging & trussing team that Area Four Industries have put together.**

We would like to introduce the Rigging Commandos, an elite rigging & trussing team that Area Four Industries have put together.

Area Four Industries educates the rigging market by providing educational videos on its A4I.tv portal and free courses for riggers all over the world.

We aim to make riggers' work easier, quicker, and above all, safer thus Rigging Commandos was created. It took us a long time, but we succeeded!

Rigging Commandos is an group of respected experts who take an in-depth view of topics exciting interest within the industry. They indentify closely with riggers and technicians and are constantly looking at ways to increase safety and efficiency at work.

These people understand their work like no one else. Not only dry teachers, but respected experts. They are people who, apart from being professional theorists, can also work hard, have a human dimension, and are not afraid to make jokes and have fun.



# Let's meet the team! Team is made up of really experienced team members.



**Eric Porter,**

British Rigging Consultant and Head Rigging Commando, with his practical knowledge and world-wide tour experience that goes back almost fifty years.



**Dipl.-Ing Norbert Tripp,**

German Structural Engineer and Area Four Industries' Technical Director, focuses on static calculations, physical truss characteristics and support structure physics that keep you working smarter and safer.



**Siobhan Colleen**

is an spokesperson for Area Four Industries, instructional designer and content strategist with a background in rigging, fall protection, and rescue instruction for the wind energy and entertainment sectors.



**Will Todd,**

TOMCAT COO and highly experienced tough guy in the rigging & trussing arena, serves as the hard-hitting expert who attacks rigging & trussing practices and products needed for your daily entertainment production activities.



**Adrian Forbes Black,**

TOMCAT/JTE/Area Four Industries America Sales & Marketing Director, sneaks you behind the curtain of the rigging & trussing world to reveal the tips, valuable rigging practices and product knowledge gathered over his decades of experience on both American and British soil.



**Eric Laanstra,**

hailing from the Netherlands, Eric has worked at PROLYTE for 20 years, first in sales and then for the past 10 years as ProductManager. With the arrival of Eric Laanstra, the "You Know What. We Know How," philosophy of Area Four Industries is certain to continue influencing and improving industry standards.



# DARTH WELDER

The world is one big stage, and we make those stages. Today's world is fascinated by social networks, artificial intelligence and digital technologies. Man is still made of flesh and blood, and as long as he uses his eyes, ears, nose and hands, he will always seek out physical stages, not virtual ones. See the faces and bodies of the people who make the stages at MILOS — with their hands and their heads.

Text by Pavel Vondráček Photo by Dan Vojtěch

[www.areaofindustries.com/talents](http://www.areaofindustries.com/talents)

Inside Company

## Production Operator

**What do you prefer, Lidl or Kaufland?**

I don't buy food, but stuff for manufacturing of structures.

**So you wouldn't buy the owner a hot dog?**

No, bullying has no place here.

**Even if he begged you on his knees?**

Nope, he won't buy bolts, nuts, pipes or sausages for me either.



See more at:

[www.areafourindustries.com/talents](http://www.areafourindustries.com/talents)

## Production Supervisor

**What does a supervisor need to work?**

Sugar, a whip and modesty.

**Is it hard to handle?**

It's hard to be modest as a supervisor.

**What do you enjoy most about the work?**

Supervision and modesty.



See more at:

[www.areafourindustries.com/talents](http://www.areafourindustries.com/talents)

**Find a role where you can build an exceptional experience for yourself!**

Area Four Industries is still hiring new talents to strengthen the team. An open opportunity to join one of the biggest players in the field of entertainment industry with branches all over the world.

Don't wait and visit [www.areafourindustries.com/talents](http://www.areafourindustries.com/talents). Page what is constantly updated with latest opened positions in our companies around the world.

## Pre-Worker for Welding

### What hero are you closest to?

Ferdia the Ant and the slogan *Work of all kinds*.

### That's a fairy tale character, but what about the real one?

The nurse at the dentist. The doctor can't fix teeth without her, and the company can't produce anything without me.

### Are you respected in the company?

Even the company owner bows down to me!



## Welder

### Why do you weld?

It's a real job. The fire, the sparks, the roar, the energy.

### What do you enjoy about it?

The result you can physically touch.

### How long do you want to do this?

As long as possible, because we have a clear head after work.



See more at:

[www.areafourindustries.com/talents](http://www.areafourindustries.com/talents)

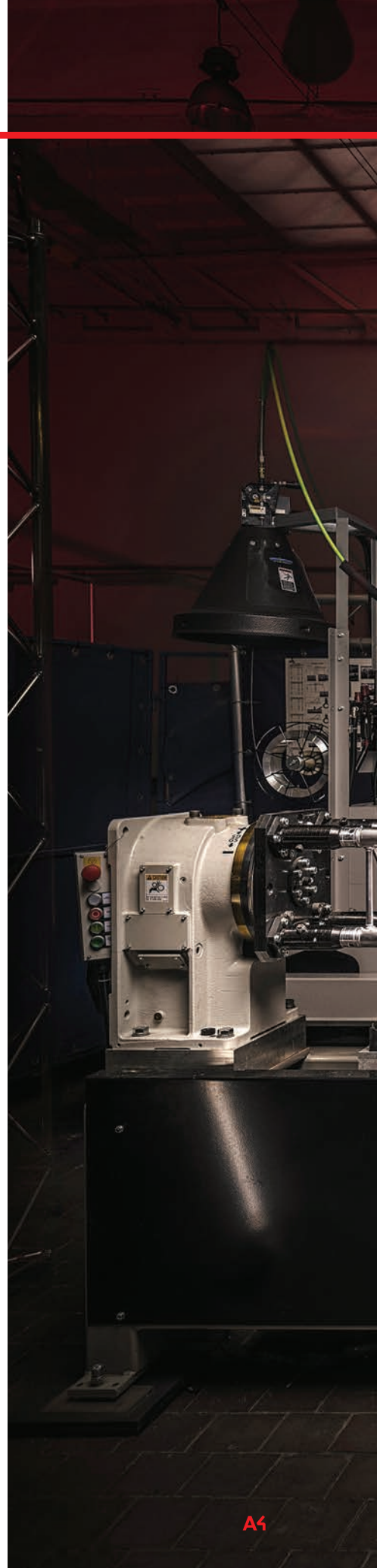

## Robot Operator

**Are you popular among robots?**

For one, I am zero; for the other, number one.

**What is best about your relations to robots?**

They never talk back.

**What do you, as a human being, common with robots?**

We both need to turn off at times.



See more at:

[www.areafourindustries.com/talents](http://www.areafourindustries.com/talents)

## Packaging and Shipping Operator

**Do you like picking up things?**

Every guy likes to pick up.

**How hard a job is it?**

Like putting together a puzzle.

**What would you never want to pack in?**

Life.



See more at:

[www.areafourindustries.com/talents](http://www.areafourindustries.com/talents)



## Warehouseman

**How would you define a warehouseman?**  
An ant that has to do the work of an elephant.

**Was it hard to tame a forklift?**  
An intellectual couldn't do it.

**What is your motto?**  
The Czech motto *Ordnung muss sein!*

See more at:  
[www.areafourindustries.com/talents](http://www.areafourindustries.com/talents)

**Milos.  
Works better.**





## Milos. A 25+ years young brand, with fast, flexible, and affordable quality solutions.

MILOS was once a small 'garage' outfit, but now it is a brand with an international reputation.

Company with two very simple concepts: simplicity & affordability without compromising quality. These values were quickly appreciated by customers and were behind the rapidly growing success of MILOS.

The name MILOS was chosen by Franti in honor of his grandfather, with whom he spent a lot of time in his childhood.

The performance of MILOS is currently driven by incredibly enthusiastic professionals and operates two state-of-the-art factories in Europe and Asia. Its products can be found on every continent in more than 40 countries.

MILOS benefits from having an extensive industrial tradition and experience that has been successfully transferred from the automotive industry. Work is constantly carried out to improve and simplify this production process.

- **Simplicity**
- **Speed of production**
- **Affordability**
- **Ready-made solutions**
- **Flexible production process system (in-house)**

# Ultra- High-Strength Steel That Takes Loading To The EXTREME!

MILOS Steel series trusses were used at the main stage of the Out in the Green Festival, held in Frauenfeld, Switzerland.

To create a massive roof of this size, riggers and construction workers used Milos Tower trusses S-QTPT, with the main grid utilising the MILOS S-RTW.

Both trusses were of course made of ultra-high strength steel to withstand the phenomenal load.

The roof was supported by 6 towers and 3 main spans of 24metres. The clearance height of the stage was 18,4 metres with an approximate total loading capacity of 125 tons.

Milos is more than happy that our products are ideal for this sort of demanding structure, and one of our best customers, MALECON, which enabled the actual construction, did an absolutely fantastic job.



**Milos. A 25+ years young brand, with fast, flexible, and affordable quality solutions. "Milos works better"**



# Experience and know-how, together with a wide portfolio of products.

**Can you tell us a little about the MILOS Brand for those unfamiliar with it?**

Milos is a well-known truss manufacturing company based in Czechia with three decades of successful history and experience. Milos employs highly experienced professionals who move us forward and bring new ideas every day.

**Can you tell us a little about your responsibilities at MILOS?**

I'm a sales department manager at MILOS CZ.

**What do you think makes the brand unique?**

Experience and know-how, together with a wide portfolio of products that guarantee solutions even for the most challenging projects.

**Can you tell us which product you consider the most interesting?**

Our steel truss range — because it makes a key difference in our Milos portfolio on the market.

**What has been the biggest challenge for MILOS in the past year, 2022?**

Re-start after Covid – an increase of capacity in production and the effort to make complete workflow more efficient and satisfactory for customers.

**Do you see the customers' needs changing as time goes by, or do they remain the same?**

I can see changes; they are more demanding, for example, concerning lead times.

**What is a typical day for you? What issues are you normally dealing with during the day?**

My typical day is full of calls, meetings, and e-mails — a usual managerial activity. I try to do my best to provide our customers with the expected level of service and also behave as the right example for my team.

**How does the future look for MILOS products? What plans do you have at MILOS for the near future?**

Use of steel trusses on big roofs. And, of course, the robotic welding era is coming...



**Lukas Tuzar**  
MILOS Sales Manager





# A Blood Rigging Guide

**Riggers don't hesitate to lend a helping hand to their colleagues when they find themselves in trouble while building a podium. Free blood donation is basically the same thing; only it saves the lives of people whose life constructions are falling apart. Czech employees of Area Four Industries donate their blood every year. In fact, blood donation has a long tradition overall in the Czech Republic; after all, this country is where blood groups were first discovered.**



Text by Radek Kovanda • Photo by Pavel Vondráček

**Blood.** The perfect composite material in a liquid form. It transports energy in the form of oxygen and nutrients to our cells, removes waste products, destroys substances and micro-organisms hostile to the body, and also has a self-repair mechanism in the event of a disruption of the blood distribution system, the total length of which in the average human body is about 60 thousand miles / almost 100 thousand kilometres. If the entire vascular system could be stretched in one continuous line, it would circle the globe around the equator 2 and a half times. But there is a relatively small volume of blood flowing through it that would fit into a larger jar - about 5 litres / 9 pints.

Blood still plays an important symbolic role in Central Europe today because perhaps nowhere else in the world will you find traditional winter slaughters, in which the blood captured from the wide-cut throat of the pig is gradually transformed into soup or tripe by constant stirring and then cooking with spices. And perhaps nowhere else in the world has there been an artist like the Austrian Hermann Nitsch, who used pig's blood to create impressive works of art.

People have been fascinated by blood since time immemorial. Blood, as a symbol of life, is present in all religions. Blood sacrifices are attested from ancient times — some cultural anthropologists link these to modern blood donation, which actually represents a form of blood sacrifice, only unlike in pagan times, demonstrably usable instead of abstract appeasement of the gods to help fellow human beings concretely.

Blood is also the central theme of the phenomenon called feud or vendetta, because it was considered the primary carrier of the kinship of individual families, clans, tribes — the so-called blood kinship. It was not until the beginning of the 20th century when irrefutable evidence emerged that blood is quite different, that it is essentially divided

into only four distinct types, and that different blood can circulate in the womb of a mother and her child, yet in some areas the belief in the power of blood as a defining marker of identity prevails.

The unbreakable legacy of blood kinship could be 'circumvented' for all in the form of a 'blood oath', which consisted of two persons desiring to enter into a blood brotherhood tasting each other's blood, usually mixed with wine, or cutting themselves on the finger, forearm or shoulder and placing the cuts together so as to 'mix' their different bloods. The practice, popularised in this country by Karl May, author of books set in the American West, is in fact known in many parts of the world. It was a tentative suggestion of blood transplants.

The first attempts at blood transfusion were in England, France and Italy in the 17th century, when animal blood was used — to treat mentally ill patients. The first successful human blood transfusion was in 1818 when the English physician James Blundell used human blood transfusion in two cases — in one case, the transfusion was successful, but the second recipient died, using blood from the same donor!

It took nearly another 90 years and dozens of similar experiments with uncertain results before the problem was solved. Three people solved it at virtually the same time without knowing about each other or their research. The first was the Viennese physician Karl Landsteiner, who dealt with the problem of transfusions in a targeted way and succeeded in defining three blood groups (A, B and O). The groups are actually four (A, B, O and AB), which was discovered in 1906 (five years after Landsteiner) by the Czech psychiatrist Janský.

He successfully transfused blood to save one of his patients who had attempted suicide. Not long afterwards, he learned of a case where a general practitioner had failed in a similar procedure, although he had given

the child the mother's blood. Janský, as a psychiatrist, thought that the properties of the blood might be dependent on the mental health of the person — in the suicide case the donor was a mentally stable man, while in the other a woman driven mad by anxiety. So he began intensive experiments, discovering four different blood types.

After WWII, the transfusions were in full swing. Czechoslovakia was one of the premier countries regarding the number of donors — the local Red Cross managed to get one in every fifty people to donate as early as the beginning of the 1950s. Today it is even one in forty. The methods of donation are safer and more painless, the protection of both donors and recipients from infectious diseases has increased, and no longer only whole blood has to be taken, but even just some of its components (plasma, red blood cells or platelets) — one tube is used to flow the blood from your body to a separator, where the necessary components are filtered out, and the other to return the rest of the blood. After all, even if you donate "whole blood" today, it never reaches the donor's body in its entirety. In the same way that you have to break down a podium into its parts to reassemble a new and completely different podium somewhere else, your blood is broken down into its components — red blood cells, plasma and platelets — each of which is used in different types of interventions and operations.

But state-of-the-art science still can't produce artificial blood. That's why it's essential to donate blood. You never know when you'll need it yourself. Every two seconds, there's a person in the world who needs a blood transfusion. For a donor, that means giving up a few dozen minutes of his or her time five times a year at most. And he/she certainly doesn't have to worry about missing the blood. The body can make up for it very quickly — it can produce up to 18 litres of new blood a year.

# Product Highlights

## Multipurpose Cart MMC

- Sturdy plastic corners and aluminium profile connection
- Aluminium profile with multiple attachment options
- Lightweight, empty only 65kg
- Protective bumpers on all sides
- Supplied flat-packed for ease of shipping
- Up to 400kg capacity
- Shelf, lighting, ballroom floors, cables, plastic crates accessories
- Multi-purpose use for materials / accessories handling and storage



## Concrete Ballast Base MCBB

- 550 kg mass weight
- Stackable for extra weights/for easier transport
- Compact 800x800x400mm steel reinforced concrete block
- Fork lift pocket for easy moving/stacking
- Center hanging point for easy manipulation
- Integrated screwjack sleeve tube for leveling
- M290 and M390 truss connection via thick steel plate including lugs for wires

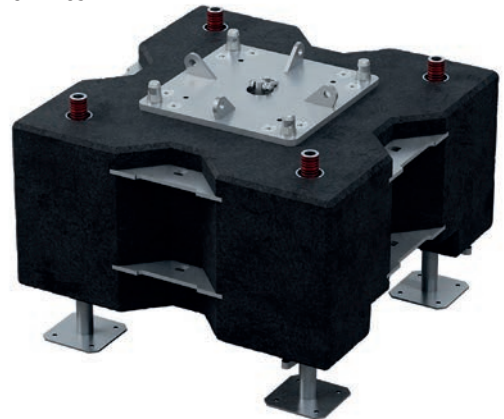
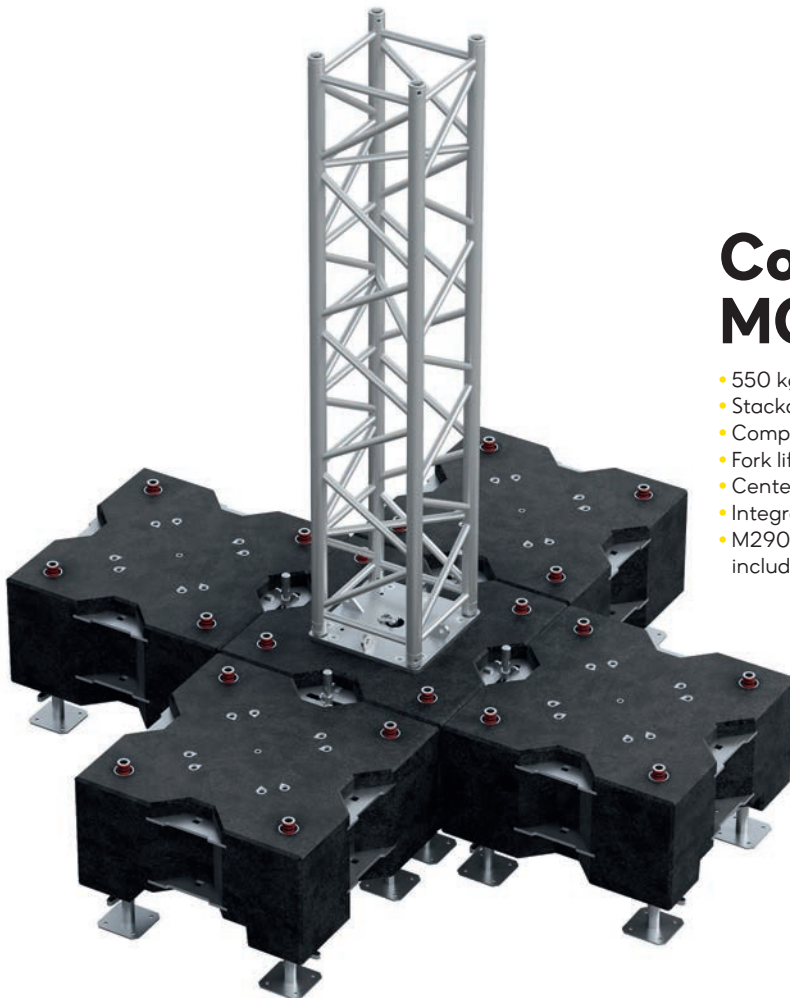

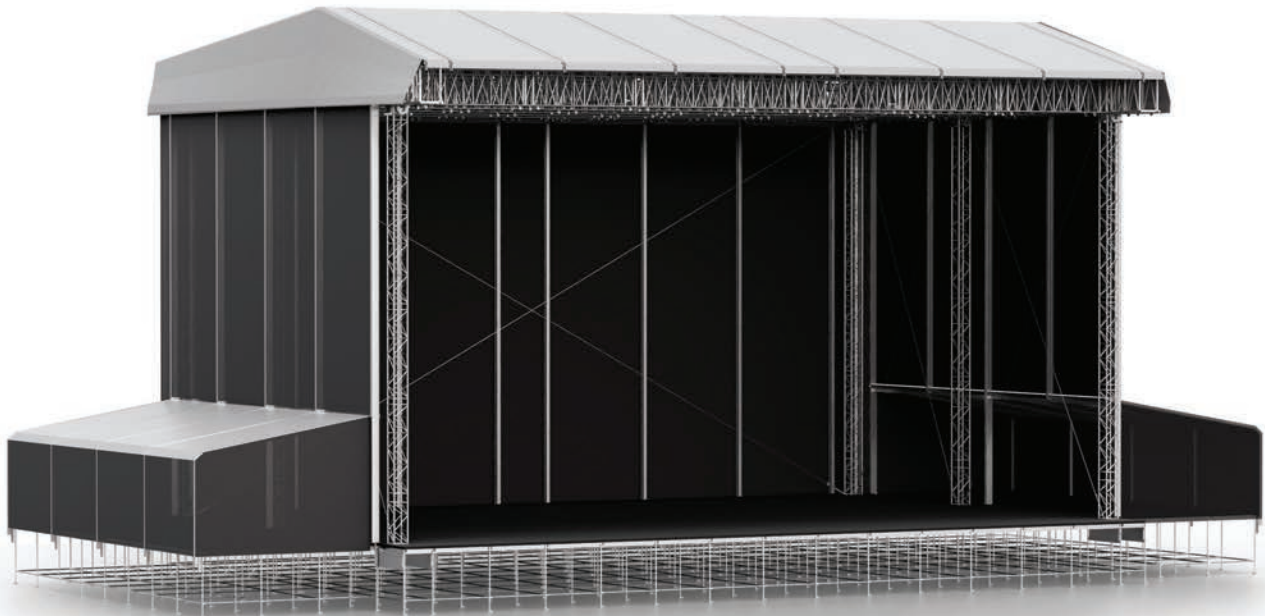

## MR6 Roof

- MR6 large scale pitched roof structure
- Main grid made of 5 spans of M1200 RTR truss
- Clearance height nearly 14 m
- Side stage structures on request
- PA / video wing options available on request

## MT-ICON-PA

Free standing PA tower for both indoor and outdoor application, from small to large events.

### MRT 1 ICON

- Height up to 5m
- Capacity 400 kg
- M290 Truss type
- Icon base

### MRT 2 ICON

- Height up to 8m
- Capacity 800 kg
- M390 Truss type
- Icon base

### MRT 3 ICON

- Height up to 10m
- Capacity 1000 kg
- M520 Truss type
- Icon base

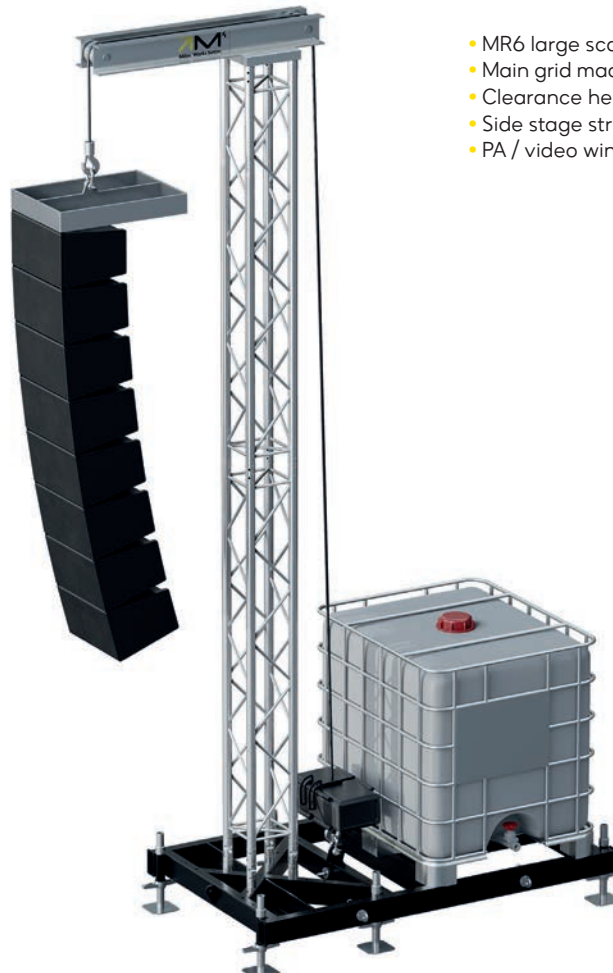

# Steel Roof S-MR20

- Overall dimensions 54 m x 24.5 m x 23 m
- 32 m span
- 4 m front cantilever
- 50.000 kg UDL

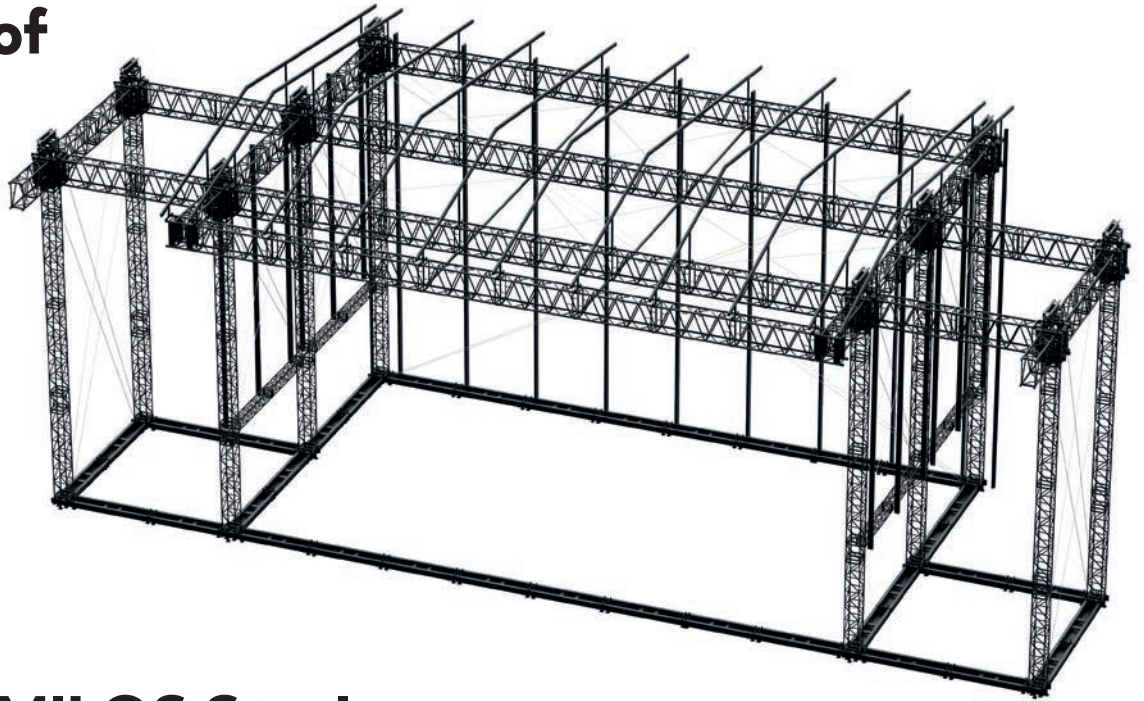

## MILOS Steel Tower S-MT-P:

- Constructed with MILOS S-QTPT Ultra-High-Strength Steel Truss (530x530mm: 35m span with 69kg/m UDL)
- Steel head-section with aluminium wheels and heavy duty bearings
- Integrated steel base with outriggers that interconnect towers in ground support systems or outriggers used by themselves for self-standing towers
- Optimised dimensions for packaging and/or nesting in truck
- Pinned connectors for increased safety and strength
- End frames equipped with lateral connection options
- Locking unit with capacity 45 333 kg



## MILOS M1200 - RTR Truss

- New connection type-R
- Incredible robustness, strength, and reliability
- Internal support for inserting a smaller truss for storing and transport
- Main chord of 60mm allows the use of CELL 300
- End frames designed of rectangular profiles incl. mounting holes for e.g. keder supports, supports for storing and transport of tower truss inside the truss, etc.



# Keder Profiles

- Custom profile with optimized strength-to-weight ratio
- Incl. channel 31x10 mm for M12 hammerhead bolts
- Max. point load in channel 600 kg
- Internal connectors for all rectangle profiles available
- Anodization on request
- Standard length 6 m
- Other lengths and custom machining on request
- Profile includes drilling line marked in side flanges for ease of fabrication

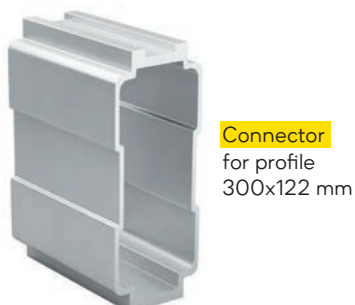
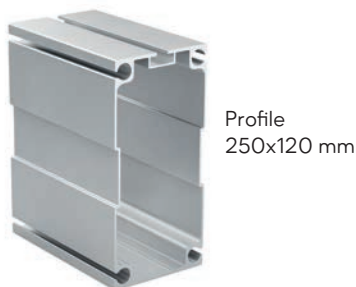
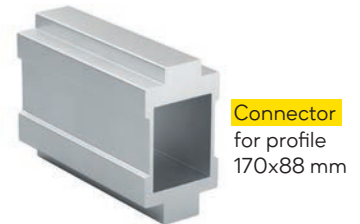
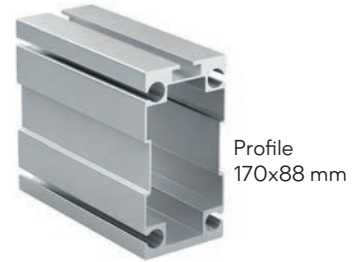
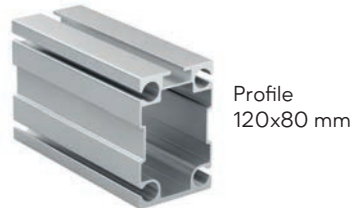



# Quality Ingredients Essential Not Just When Cooking

---

Whatever you make, quality ingredients are the basis of future success

Metallurgical materials are one of the most critical parts for the production of most of our products. These include pipes, rods, profiles, sheets etc. To produce the highest quality products, products that are long-lasting, efficient and safe, however, it is necessary to pay the utmost attention to the materials from which these products are made. Therefore, our products result from a quality manufacturing process and a quality supply of raw materials.

We manufacture our products from materials produced to the required standards by certified manufacturers, from required materials and in a controlled manufacturing process. Samples are taken from every production batch according to specifications, and these are tested and evaluated. Manufacturers record the information obtained, and their inspection officers confirm its quality in the documents sent by the manufacturer to us with the delivery.

Once the material arrives at our site, staff at our inspection department physically inspects the delivered material for dimensions, surface quality and mechanical properties. Once it is ascertained that the delivery meets all the requirements it is released into our manufacturing process.

The quality and safety of our products are a constant priority for us. This is the only way we can guarantee the state-of-the-art quality of our products.

# Strutture Soluzioni Sinergie



# Brilliant future for LITEC

---

LITEC was started by an ambitious Italian visionary, Giuliano Luvisotto in 1991, in the city of Marcon, on the outskirts of Venice.

Since 2012, the company has been managed by Fabio Prada. Since that time, the company has been constantly growing thanks to the use of synergies between established customers in foreign markets and confirming and consolidating its number 1 position in Italy by focusing on LITEC's specific design philosophy.

- **In-house development**
- **Custom made solutions**
- **Quick delivery**
- **Focus on detail**
- **Italian Design**

[www.litectruss.com](http://www.litectruss.com)

# Opportunities in the event industry



## Carlo Ughelini

LITEC Product Strategist

### **From the start, tell us how long have you worked at LITEC**

I have been working at A4i for two years, where I am responsible for the LITEC brand and also oversee the technology area of Flexa Sensors.

### **Can you tell us little about your responsibilities in the company?**

My responsibilities include developing new products and refining existing ones for LITEC, as well as handling some operational tasks for the Flexa brand. Additionally, I am involved in client meetings for training and consulting during installations.

### **How do you look back at the last two years?**

Looking back at the past two years, it has been a period of growth and innovation for the company, with the introduction of new products, updates to the existing range, and ongoing relationship with end customers.

### **How does the future look for the LITEC product? What plans do you have for the far future?**

The future of the LITEC product is very promising, with projects underway for the development of new innovative solutions and the expansion of our market into new areas. I believe that a larger market share can also be achieved with the support and service of designing tailor-made solutions.

### **What do you see as your biggest opportunity in the market?**

I see many market opportunities in the event structure industry, with a growing demand for high-performance solutions and an increasing use of hybrid solution using both special steels and aluminium for the construction of large structures.

### **Are customer needs and requirements changing?**

Yes, customer needs and requirements are constantly changing and adapting to new technologies and market trends. This requires us to always stay ahead of the game and find innovative solutions to meet their demands.

### **What is a typical day for you? What issues are you normally dealing during day?**

Our market segment requires us to be very responsive to changing needs, which may vary from day to day. In addition to planned activities for range innovation, the entire technical staff is often involved in assisting the design of special structures requested by customers.

### **What plans LITEC has for this year?**

Some of LITEC's projects for this year include the development of new solutions in special steel and a series of aluminum range updates that are still confidential. In any case, both product development and support for our clients' work will be intense and stimulating activities.

# Designing According to UX/UI Protocols

Designing means transforming an idea into a product that will almost always be used by others. Working in the professional sector of event structures requires designers to pursue two main objectives: performance and safety. The best performances are achieved through the use of innovative materials and technologies. Safety is ensured by strict adherence to technical and structural parameters, as well as international regulations.

However, two new protocols are also added for achieving other important objectives: the UX (User Experience) and UI (User Interface). These are protocols that originated in the IT world but now involve every product used by a user. If the overall user experience is positive, the user will have a friendly approach when interfacing with the product and its functions. To develop a design according to UX/UI protocols, every designer on our staff must adopt the user's point of view, engage in dialogue with them, and participate in the setup phases. Information exchange and sharing of experiences is our design method.

user experience is positive, the user will have a friendly approach when interfacing with the product and its functions. To develop a design according to UX/UI protocols, every designer on our staff must adopt the user's point of view, engage in dialogue with them, and participate in the setup phases. Information exchange and sharing of experiences is our design method.







# Towns on the Laguna

It's just eight kilometers from the gates of the Litec factory in Casale sul Sile to the shores of the Venetian lagoon.

But it's not just the beautiful city of Venice that glitters in the middle of the lagoon; there are also other, much smaller towns. When you leave Litec, stay a while and take a trip around the lagoon. It's worth it.

## VENICE

The origins of this world-famous water town date back to the 5th century AD, when the inhabitants of the surrounding villages and towns settled on small muddy islands, fleeing the raids of the Huns and the Germans. Over the centuries, this emergency refuge became a powerful city that, at its peak, ruled not only in the cultural field. The charm of the city "floating" in the Venetian lagoon, whose 118 islands are connected as arteries by four hundred ancient bridges, is undeniable. Even so, there are similar cities in the immediate vicinity, rising out of the water, that are equal to Venice in beauty or unique atmosphere.

## CHIOGGIA

While the picturesque islet of Burano, like Venice, nowadays lives mainly on tourism, life in the island town of Chioggia, located at the entrance to the Venetian lagoon, goes on at the normal pace of everyday life. The "little Venice" does not lack the charm of its historic buildings, lined by a perpendicular series of water channels, but neither does it lack the spirit of an ever-living city, full of real inhabitants with their everyday sorrows and joys.



## BURANO

Burano is a stone's throw from Venice — seven kilometers can be covered by the local water public transport in 45 minutes. The colorful town of 3,000 inhabitants (there used to be up to 8,000 on the island) was once a forgotten fishing neighbor of the famous city. Today it is a popular picturesque reminder of the old days of life on the isolated island.

# Product Highlights

## Dual Power-Tower Sleeve Block

### We divided the towers to have twice the capacity

The Dual Power-Tower Sleeve Block integrates two LITEC QL52 aluminum truss towers and a single connection for horizontal LITEC Myt Steroid Folding truss.

The rise & fall is controlled via polyethylene pads to give stability and fluidity of movement.



On this application, the system comprises LITEC Multi-tower Heavy Duty Bases, QL52 trusses with tops and standard safety blocks. The new LITEC MTB – Multi Tower Base are connected by a link module supplied with the special configuration sleeve block.

A simple and easy-to-implement solution. The advantages are immediate and, sometimes, allow set-ups in environments where it would be complicated or prohibited to raise heavier towers.

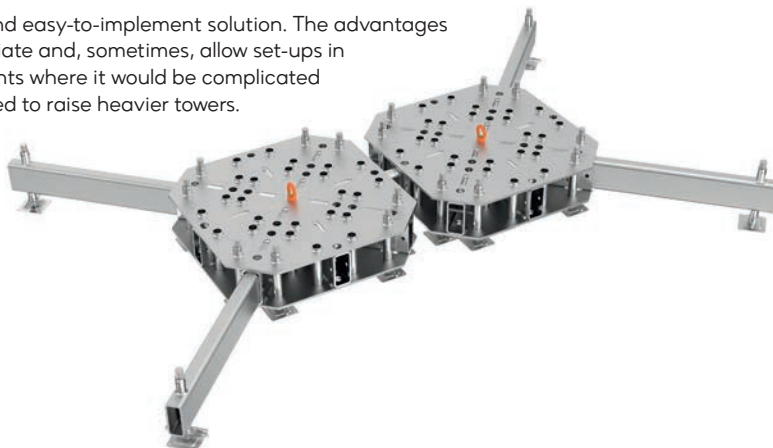

## A robust and attractive tower



### A simple solution to build large-scale towers with clear advantages:

- No need to use, purchase, or rent a single heavy tower compatible with Myt Steroid Folding spans;
- Use of LITEC QL52 aluminum truss, very common and easily available;
- Installation without the need for large lifting cranes;
- The simultaneous use of 2 chain hoists in the same tower.

### Useful for outdoors, and sometimes irreplaceable indoors

Easy installation of large ground support even inside sports halls, fairs, convention centers, or outdoor areas where it is difficult to use mobile crane or other heavy vehicles.

# Dual Power Tower in Action



# The Twister Sleeve Block

LITEC SAM, Swing Adjusting Module

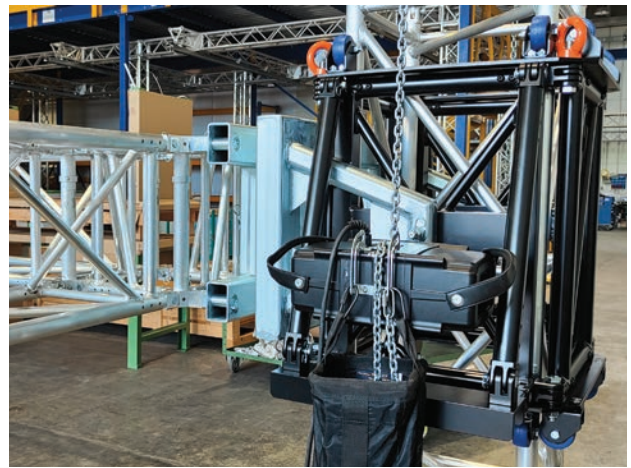

The swing adjusting module (SAM) is a 3-hinge module designed to eliminate rigid constraints between and avoid transmitting stress from the grid to the towers.

The system is based on the concept of a cardan joint that allows for bidirectional movement, leaving the grid free to follow the inherent deformations created by the load.

The SAM system is applied to a special sleeve block and is not available separately. The system cannot be retrofitted onto standard sleeve blocks.

Images of the event, courtesy of RVC Event Lighting, Malta

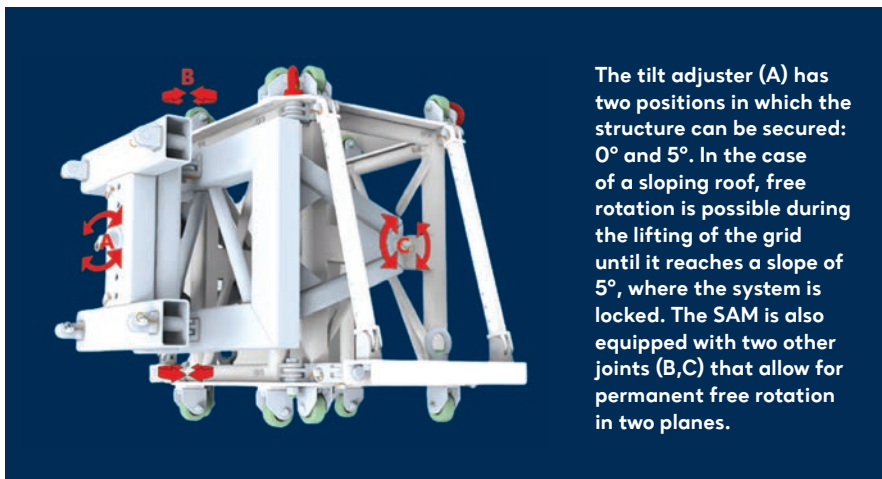

The tilt adjuster (A) has two positions in which the structure can be secured: 0° and 5°. In the case of a sloping roof, free rotation is possible during the lifting of the grid until it reaches a slope of 5°, where the system is locked. The SAM is also equipped with two other joints (B,C) that allow for permanent free rotation in two planes.

## From operational tests ...

What SAM can do is much more than can be explained. While its operation is automatic because it is self-leveling, operational tests with oscillations and misalignment of the trusses have confirmed the perfect functionality of this device that simplifies a complex problem.

## ...to the live use.

Any stress, other than pure vertical load, is nullified on the SAM sleeve-block because it transfers only the vertical load to the tower, thus maximizing its load capacity. The SAM clearance tolerance allows for a slight correction to the positioning of the towers even during advanced setup.

# Super Universal Base of the new HiPe Steel Series Heavy-duty MTB - Multi Tower Base

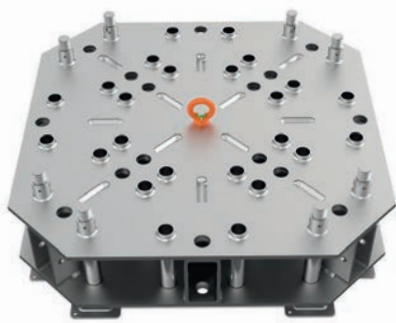

Extreme versatility, designed to accept towers from **40cm to 85cm**. A single base, ready for any use. A sandwich of two steel plates weighing **500kg** with **8 adjust-able Layer base plate** to ensure perfect leveling and even load distribution.

The legs are easily mountable and removable. They adapt to a **90° cross configuration** or a **45° ,X' configuration**. This allows to fix the towers with the correct orientation. Each leg is equipped with an **original adjustable Layer Base Plate**.

Each leg is independent and does not interfere with the others. If necessary, for specific mounting requirements, it is easy to increase the number **up to the 8 available slots**.







## Versatility as a Key Attribute

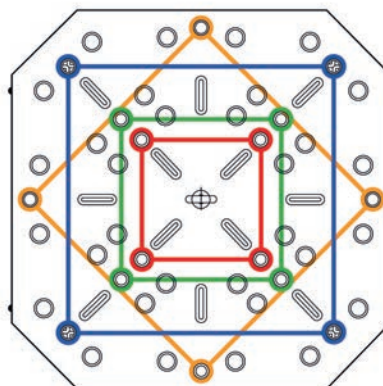

### Fork & Conical connectivity

All connectors are fork-terminal and are fixed to the base with **M30 bolts**. The aluminum connector for the **LITEC QL40** tower is supplied with a **spigot adapter**.



-  QL 40 / QH 40 / QX 40
-  QL 52
-  QL 76
-  QL 85



### Compatibility between multi-brand towers

With custom-designed connectors, the **Heavy Duty MTB** can accommodate most existing square towers on the market and is ready to adapt to new future towers with measurements between **40 and 86cm**.

**Versatility, safety, cost-effectiveness.** LITEC is close to professionals with solutions that simplify procedures.

# The brand-new Range of Telescopic and Front Load Lifts

In most setups, there are almost always loads to be lifted. Xlift towers have been designed for lifting loads ranging from 125kg to 500kg. Each tower has a Safety Stop, which is a mechanical device that locks each section in the event of a winch malfunction or towing cable breakage, preventing accidental descent.



**XLT-125**

**Maximum height:** 3.8 m (12.5')  
**Folded height:** 1.26 m (4.1')  
**WLL:** 125 kg (275 lb)



**XLT-150**

**Maximum height:** 5.35 m (17.5')  
**Folded height:** 1.72 m (5.6')  
**WLL:** 150 kg (331 lb)



**XLT-300**

**Maximum height:** 6.5 m (21.3')  
**Folded height:** 1.87 m (6.1')  
**WLL:** 300 kg (661 lb)



The Xlift 270, weighing just 123kg, is among the lightest in its category. It is made up of 5 sections of aluminum profile, each with the Safety Stop system for maximum safety. The steel base is mounted on 4 swivel wheels for easy positioning and transport.

## XLF-270

**Maximum height:** 6.65 m (21.81')

**Folded height:** 1.78 m (5.84')

**WLL:** 144 kg (317.47 lb)



The Xlift 500 is also composed of 5 sections of aluminum profile, each with the Safety Stop system for maximum safety. Each section is equipped with eyebolts so the lifter can be fixed at any height. The steel base is mounted on 4 swivel wheels for easy positioning and transport. On this model, two additional rear wheels and one central wheel are provided for horizontal transport,

## XLF-500

**Maximum height:** 7 m (23')

**Folded height:** 1.90 m (6.23')

**WLL:** 223 kg (492 lb)

# We are looking for a Lecturer!

Join us in our mission to educate and empower the next generation of rigging professionals!

See more at:  
[areafourindustries.com/talents](https://areafourindustries.com/talents)





# Elevate Your Style with A4I Merchandise

Check out our clothing pieces that are sure to fit you well at work or at home on the couch. You can choose from all the popular brands under Area Four Industries, such as MILOS, LITEC, PROLYTE or TOMCAT. You can choose from comfortable T-shirts and polo shirts, sweatshirts and vests or headwear, plain caps and baseball caps. Now just choose!



Caps



T-shirts



Polo-shirts



Gilets



30 Years Anniversary Edition



Hoodies

# How big are states? And how do the maps lie?

**Area Four Industries is a global company. But everything is relative, even the size of countries. Not so much because of the occasional boundary changes as because of the projection of the surface of the sphere onto a flat surface.**

The most widely used world map format is based on the old method of the plan view, which was invented by the Flemish cartographer Gerhard Mercator in 1569, primarily as an aid to seafarers. However, it gives us a distorted idea of the size of countries and continents. In Mercator's depiction, everything from the equator to the poles stretches disproportionately from side to side. Greenland looks as big as the whole of South America, but in reality, it is a quarter the size of Brazil. What about the Czech Republic? If it were on the equator, it would be 56% smaller visually! See how the size of large countries and continents changes when we place them on the 'optically fair' equator.

**How big is Russia really? The impression given by the distorted projection on the world map is visually deceptive.**



**How big is Antarctica? The sixth continent is the fourth largest, the smallest of all is Australia.**

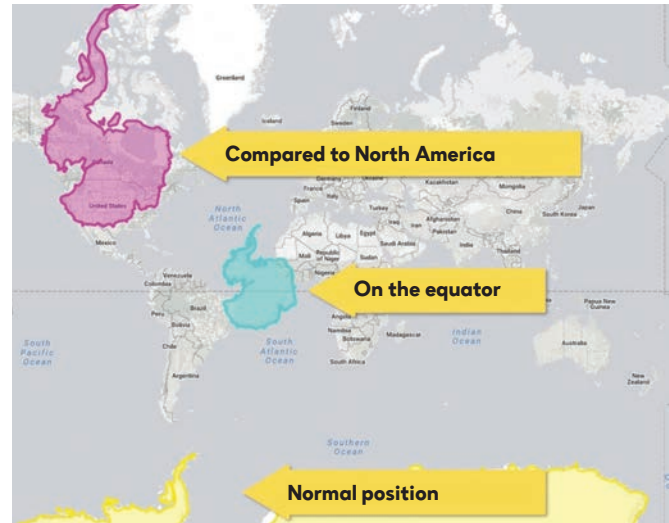

**If the Democratic Republic of Congo were located in the EU, it would occupy most of its territory.**

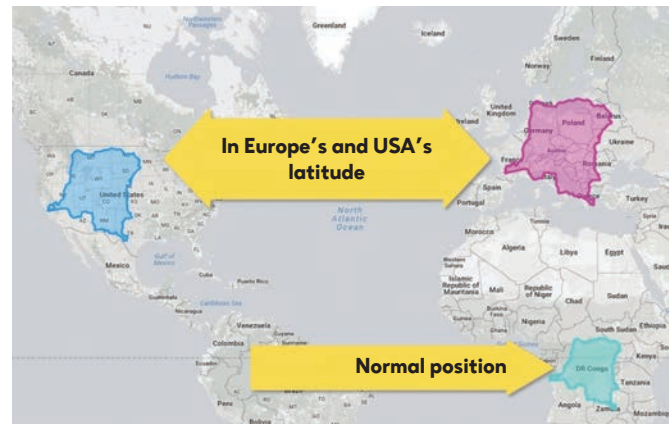

**Compared to the US and Russia, India is actually not nearly as small as it appears on the world map.**

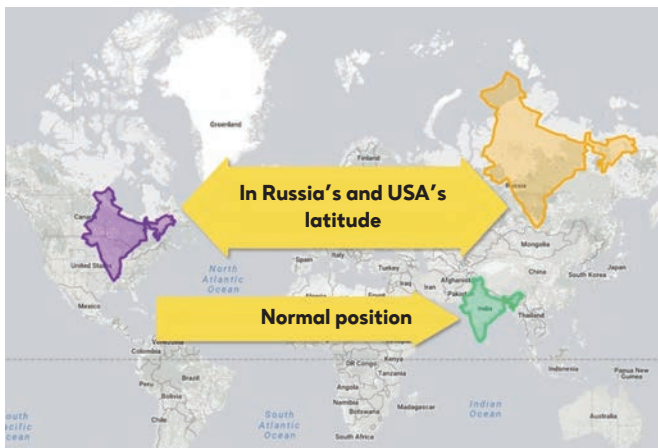

**On the world map, Mexico does not seem to be a very big country, but again appearances are deceiving.**



text Radek Kovanda, foto Google maps, Wikimedia

This is how big the **top six countries** would look on a world map if they were on the equator.



Although **Australia** doesn't seem like a particularly large continent, it is only a tenth the size of Europe.

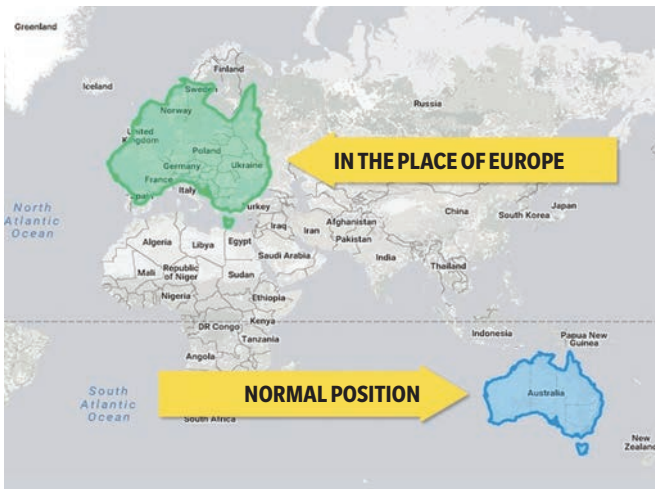

On a world map, **Greenland** is bigger than Australia and as big as South America. Don't be mistaken!

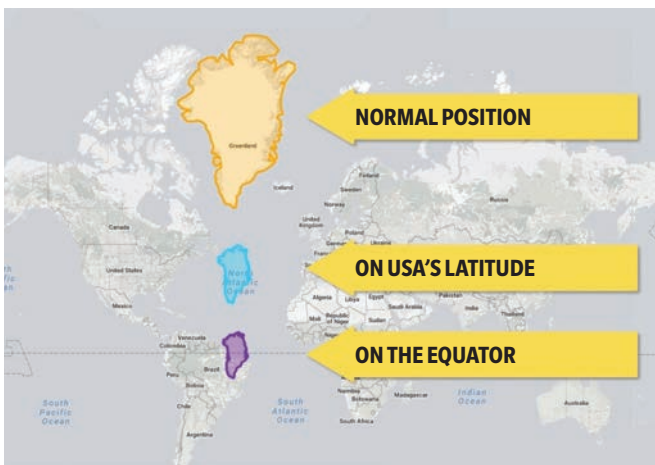

The most populous country in the world is **China**, although it doesn't look very big on the map, but shift it up...



### TRUER MAP VIEWS

Mercator's projection has been accused of making us see Africa as a marginal continent because it visually enlarges Europe and the US.

The **Gall-Peters representation**, with the correct sizes (but no longer shapes) of the continents, was introduced in 1973 and adopted by many international and ecclesiastical organizations as a better alternative to Mercator.



**Wagner's view** - a modified azimuthal view from 1941, to which there are countless variants according to different renumbering of parallels and meridians, used in military maps.

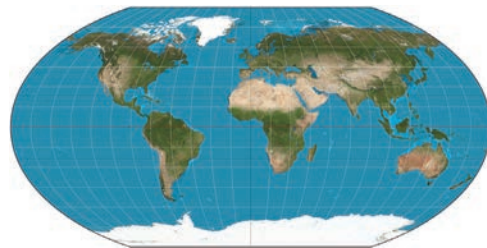

**Good's elliptical + sinusoidal representation** of 1923, in which the least distortion of the actual sizes and proportions of the continents is achieved by a disjointed representation of the meridians and poles.

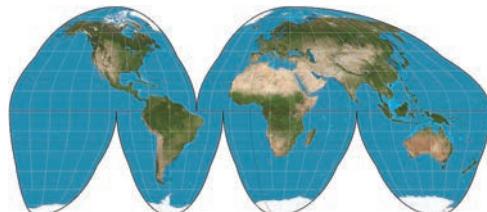

Feel.  
Fantastic.



# Customer Satisfaction

Prolyte brings something new every year. Founded in 1991 in Leek, Holland, Prolyte has quickly become famous around the world due to its in-house expertise, one step ahead mentality, and energy.

The brand's focus is on customer satisfaction which inspires riggers and industry professionals to discover new horizons within the world of events.

Prolyte is known worldwide for its iconic products including the H30V, VERTO and MPT Tower. The H30V is used by most professional rental houses worldwide as they are recognised for their strength and durability.

The latest feature of Prolyte is the VERTO coupling system, which is known for its fast and silent connecting system.

Prolyte is part of the Area Four Industries since 2019; world's largest manufacturer and supplier of aluminium and steel trusses, stage platforms and rigging material, making the implementation of larger projects now a lot quicker and easier.

Prolyte is continuously striving to make a riggers' work a whole lot easier.

- **Any kind of satisfaction; primarily customer**
- **Manufacturer not reseller**
- **One step ahead mentality**
- **Combining high craft & cutting-edge technology**
- **Always iconic & new products & solutions**



[www.prolyte.com](http://www.prolyte.com)

# Personally, I Love Life



**Eddie Slotboom**

**PROLYTE Projects Director**

**The era of covid as the enemy of the entire Entertainment industry seems to be irreversibly gone. How is Prolyte doing now?**

Prolyte is doing very well at the moment. We have an incredibly tough period behind us and that wasn't just COVID. The team has worked very hard and is stronger than ever. Our customer base, which is / was also greatly affected by the Covid, is loyal to Prolyte. During the difficult period there was a lot of communication with all stakeholders. Transparency and honesty are key words in difficult times.

Where during Covid, mainly necessary orders were placed by our customers, we now see a large stock orders and larger projects in the orderbook and pipeline.

**Has that time changed anything in the functioning of the Prolyte brand?**

The biggest change is of course that we are now part of Area Four Industries. This brings peace and stability to Prolyte. The size of Area Four Industries gives us many advantages, the multiple production location brings flexibility. And perhaps the biggest change for Prolyte, no external influences. Short lines, fast decisions. Customer Service and result oriented!

**What are the trends in the Entertainment industry now, and how does Prolyte reflect them?**

I don't really dare to say whether there are new trends already. I think everyone is still reeling and catching up from what happened during Covid. I think the "green world" will be a trend for the future. More products available locally for traveling events. Reusable materials (truss is par excellence!). And stock, stock is key. Decision moments are postponed and then it comes down to who can deliver. This is where we put a lot of energy into our worldwide distribution network where our products are available.

**What new products is Prolyte planning this year?**

We are very proud to have launched the new Prolyte Nero range last year. The demand for this was huge. This together with the new database where all Prolyte hoists are registered takes us a few steps further than where we were before Covid.

In addition, our engineers and product managers have expanded our LSU product range. Curved, raised and horizontal. The reactions to this during ISE Barcelona were very positive, we are very curious about the feedback from Frankfurt.

Then there is an extension to our Stagedex range, the Easy E is new here. A simple and easy solution for stages. Stable, meets all standards and is easy to build.

**In addition to your position at Prolyte, you are also the Product Strategist for the A4I group. What does this job entail?**

There are many different products within the Area Four Industries. Some competitors with each other, some unique. As a Product Strategist, my job is to manage that. It makes no sense to launch the same product within A4I in the same year with a different brand. It also makes no sense that a niche product of 1 of the brands is marketed under a different name. In addition, the product and brand identity is of enormous importance. There is clearly a difference in the different brands and it should be communicated as such.

**Who is Eddie Slotboom in his private life when he is not working for Prolyte / A4I?**

Personally, I love life. Humour is paramount, a day without laughter is a day wasted. At home I have 2 boys, 12 and 15 years old. Insanely nice to see them grow up, make mistakes, make discoveries, but most of all that they enjoy life. I am also convinced that having a stable partner by your side only helps, my wife Mandy works locally as a reading media coach. She just can't get me to read yet. I like sports myself Tennis as a hobby, Volleyball in competition and skiing in the winter months.

# Roof Configurator

Roof Configurator is another of our new projects. On our website, you can view our roof portfolio (all variants) and see them from many angles. We believe this is another step towards making our roof range even more transparent for you.

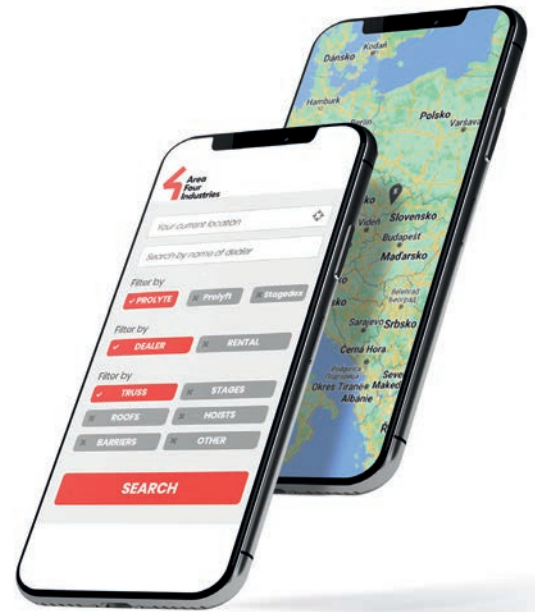
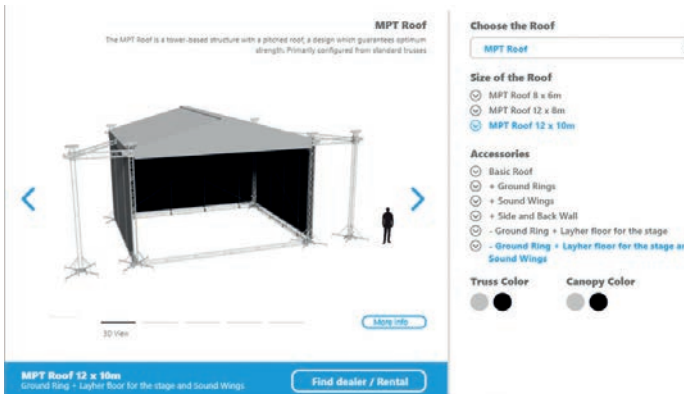

# Dealer Locator

A new feature on our website searches for the nearest partners where you can purchase Prolyte, Prolyft or Stagedex products. When you open it you will be immediately offered the location of the nearest partner. Prolyte products and services are now even closer to you.

# Circular Roof

**The buildup of our unique #CircularRoof was done last year by Prolyte's customer VERANTEC.**

Easy to build, with 18m diameter and a total height of 8 meters, Prolyte's addition is fully designed from our H40V truss series and Heavy-Duty Box corners, optimising the strength of the roof top. The 18 meters of this circular shaped roof system create a perimeter of nearly 60m and can have a payload of 50kg/m, making the structure outstanding in the market. All trusses are inside of the canopy, which gives this special roof a fantastic aesthetic look. Lifted from the ground, this circular roof and its 8 towers were used in a private event last year for one of Prolyte customers. Prolyte brings something new every year. Founded in 1991 in Leek, Netherlands, Prolyte has quickly become famous around the world due to its in-house expertise and of being one step ahead of the competition with a new mentality and new energy: "Prolyte. Feel Fantastic."



# Blu Hearter Partnership That Matters

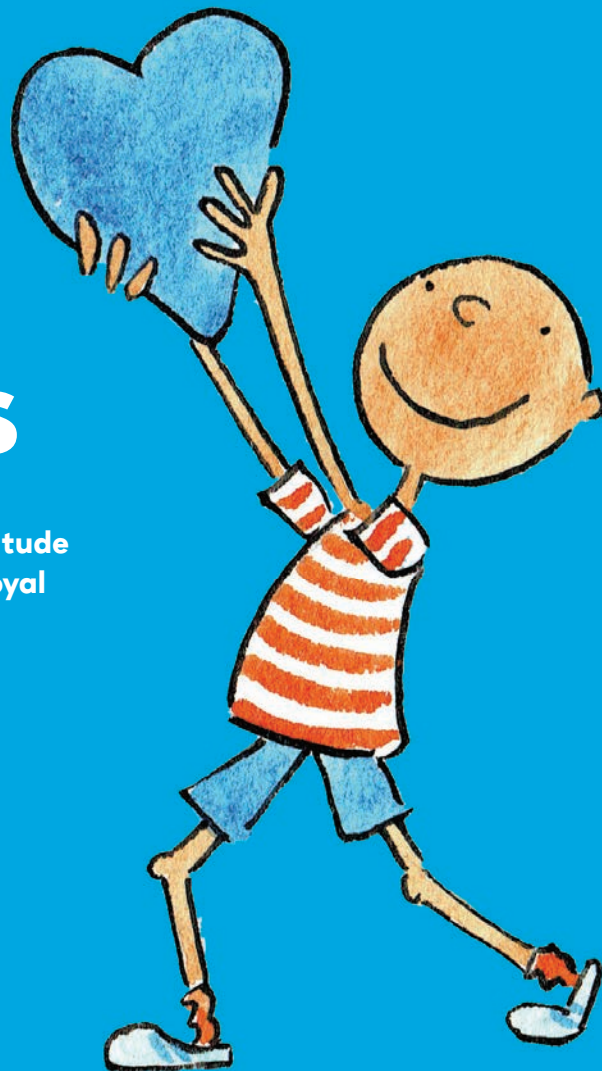

The Blu Hearter awards represent the love, gratitude and appreciation Prolyte gives and receives from loyal partners, valued customers, friends and family.

We at Prolyte value each and every one of our customers, and that's why we would like to highlight our customer's experiences and testimonies with the rest of the world!

The Blu Hearter awards are given once per month with the aim of thanking them for our loyalty and partnership.

„Partnership that matters“, is our slogan, and we want to put on the spotlight all of our ambassadors that make Prolyte what today is.

Share with us that person that you believe deserves this award by sending an email to [marketing@prolyte.com](mailto:marketing@prolyte.com) and helping us making this beautiful family bigger!

We would love to share it with the world.



**Rui Nunes**  
SLS Portugal



**Rose Oberer**  
DJP,





**Kevin Boujikian**  
Provision AVL



**Robert Izzet**  
DWR



**Dennis Brookman**  
Powersound.rent



**René Haarseim**  
Licht Produktiv



**Bas Entius**  
Controllux



**Andrejs Mefodovskis**  
PRO 1 STAGE

# A Marketplace That Shocks the Eye

The design of the Markthal building in Rotterdam, the Netherlands, catches the eye at first and second glance.

Text by Václav Rybář • Photo by Wikimedia, Shutterstock





Prolyte, a leading manufacturer of entertainment industry products, was founded in the Netherlands. But this country is one big stage for all human senses. Even the largest covered food market in Rotterdam looks like a big concert stage.

A concrete building broken at the waist so that its roof touches the ground, forming a massive tunnel painted on the inside with psychedelically falling giant fruit and vegetables. I guess that's how you would describe the bold Dutch project to someone if there were no photos. The crazy apartment building is another project by studio MRVDV (short for the founders' initials), and as you tear your eyes away from the giant painting that spans 11,000 square metres, you'll notice that the windows of the apartments shine through among the giant fruit and vegetables on the world's largest canvas. Yes, this giant horseshoe covering a busy market is full of apartments. Over two hundred tenants peer down, often at wildly unnatural angles, at the tingling deep below. The panels, covered in paint, are specially designed to block out the bustle of the marketplace so that one can quietly enjoy the vista, especially in the upper apartments, which have windows instead of floors. The architects are said to have even thought about allowing tenants to open the window and pull a basket of vegetables and fruit on a string directly from the market. However, security measures don't allow this, so you have to take the lift down to make your purchase.



Powerful computers used to render Pixar's animated films were used to process the giant illustration, the digital version of which was almost two terabytes long. The painting is the work of local artist Arno Coenen and spans 4,000 aluminium panels.

# Product Highlights

## Circular Roof

The roof is as standard available in a 12 meter and 18 meter diameter with a clearance of 6 meter.

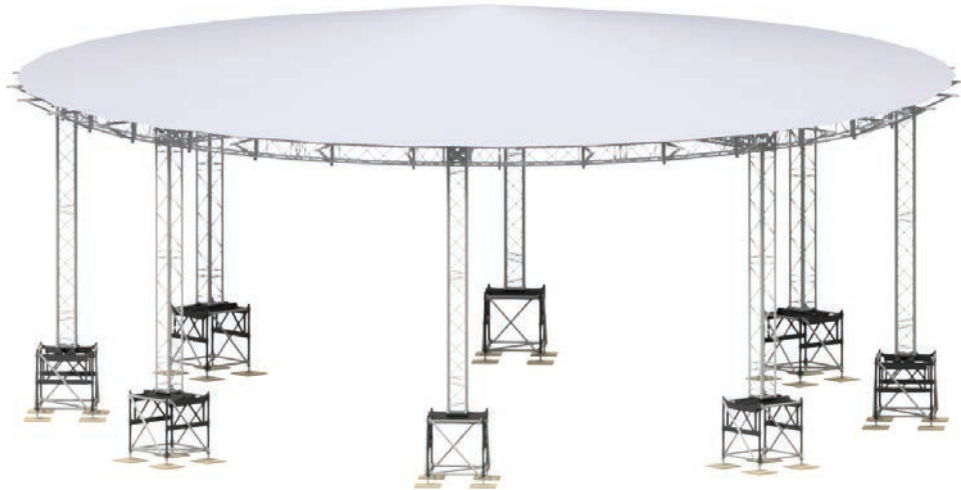

## Ramp Solution

The leg support top part is equipped with a square 40mm leg which fits in the leg pocket of the stage deck. The bottom part will take the standard 48x3mm stage deck leg, preferably with an adjustable foot. With the different hole configuration you can choose between a 1:8, 1:10, 1:16 and 1:20 ratio. In combination with the Topline Stagedex series it is even possible to mount a 100 kg railing to both sides of the ramp.



## Vario Barrier

The vario barrier is a middle-hinged corner section. It allows a set-up with more modules at any angle which makes it most flexible without making compromises. A single unit can make a corner in a range from -60 dgr until +60dgr. The Barrier folds flat after use and can be stacked in dollies for easy transportation and storage.

## LSU HS series

Prolyte introduces the next step forward in horizontal suspension of LED panels. With this universal system you are able to create a complete ceiling panels, regardless of the size of panel that is used. Nearly every brand of LED panels will fit this flexible system. The HS series is based on just one special 48,3 mm round extrusion in combination with a LED panel adapter.

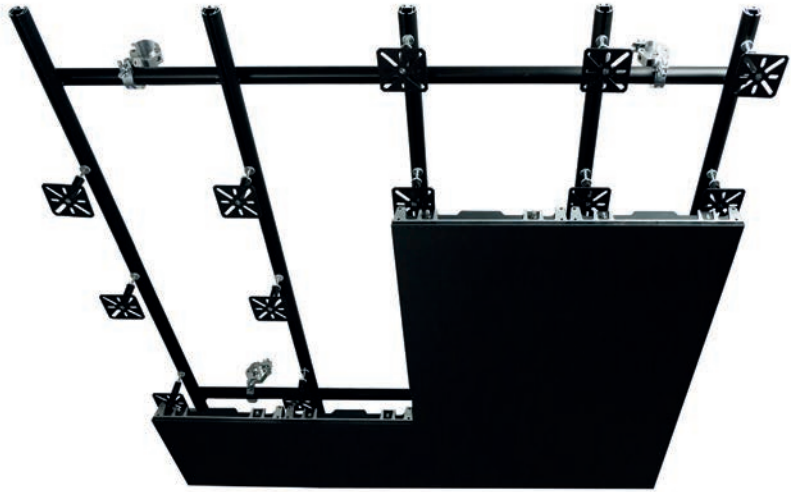

## LSU Curved

Extension of program  
Connectionbar 2,5-5-7,5-10 degrees  
Panel adapter 2,5-5-7,5-10 degrees

## LSU Raised

Extension of program  
Support leg 90-130cm



# Strength Under Pressure

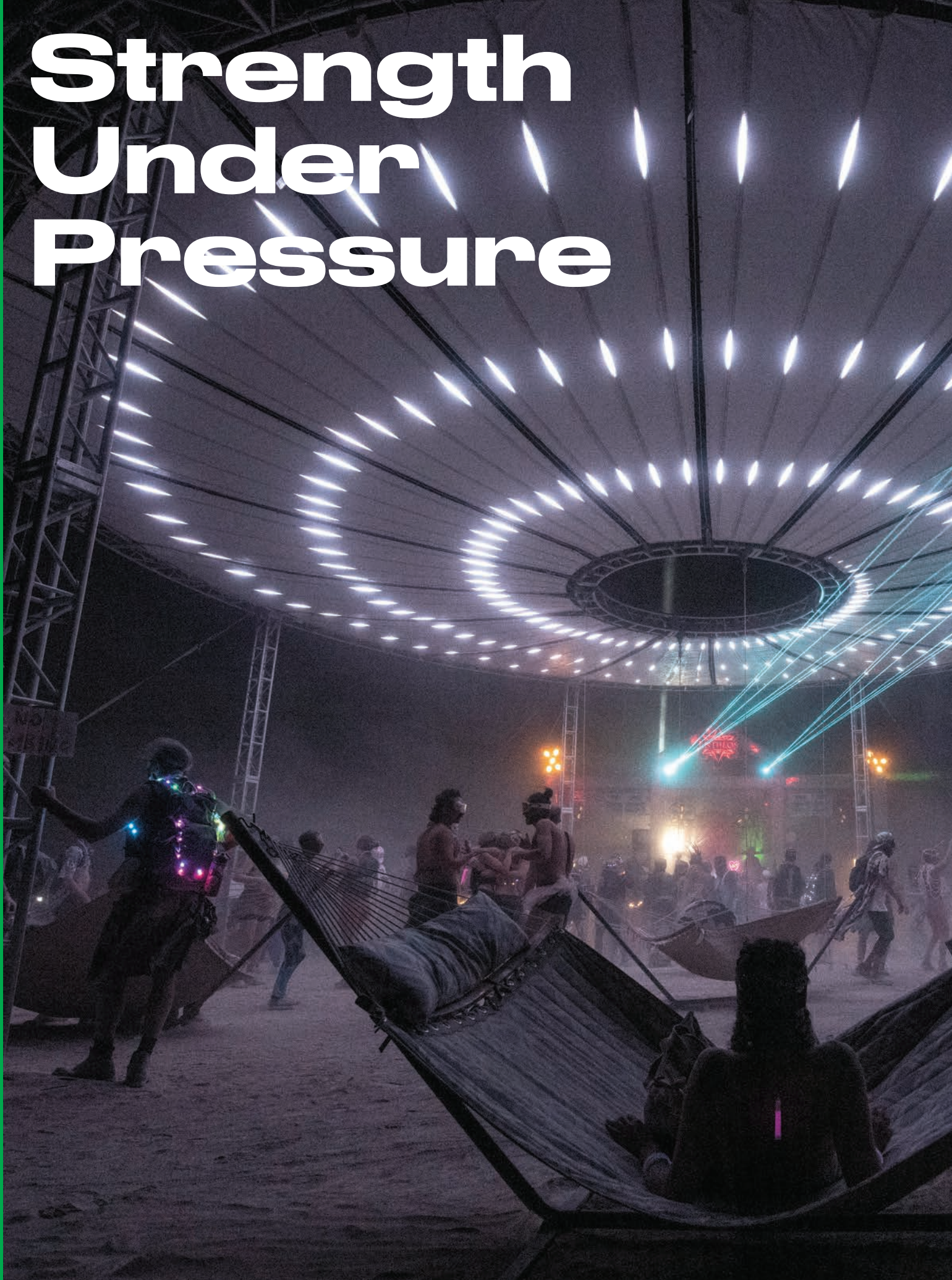



# TOMCAT Believes in Making Trusses That Are Built to Last

The TOMCAT story began with one man's vision

Texan Mitch Clark foresaw the extraordinary potential of truss. In 1985, he started his own business and founded a brand that has since met with unequalled and unending success.

This success is not only the result of paying attention to each and every product, but also building a renowned customer service.

This combination brought rapid success in the U.S, Canada and South America. In 2013, Will Todd was appointed Chief Operational Director.

TOMCAT believes in making trusses that are built to last. Because TOMCAT understands what life is like „on the road“, which combines structural power and industrial design beauty that could be found in TOMCAT Products.

By sourcing own parts and new materials from medium size producers we know personally and producing our products in our own factories, we have control over every step of production process. This ensures the utmost quality and consistency in every single piece of genuine TOMCAT product we produce.

Looking to the future, the TOMCAT brand will continue to dictate and define the direction truss and support structures take in the American market. Leading by example.

Strength Under Pressure. It's engineered into everything we do.

- **Robustness**
- **Build to last**
- **Long-term partnership**
- **American technology**
- **Huge structures**

[www.tomcatglobal.com](http://www.tomcatglobal.com)

# TOMCAT has always been a customer driven organization



**Will Todd**

**TOMCAT President/CEO**

**Will, you are now a year into holding the position of CEO of Area Four Industries America, how is that going for you?**

Overall, things have gone well. There have certainly been some learning experiences and growing pains coming out of a global pandemic combined with the continued learning of this role for me. Fortunately we have an excellent team I can rely on to keep us moving forward.

**TOMCAT just celebrated its 35th anniversary. What have been the biggest product changes in that time?**

For the most part, our core product is pretty close to what it was 35 years ago. The challenge has been developing new products that meet the ever changing needs of the entertainment industry. We have recently hired a new designer that is focused on new product development. That will help us improve our R&D process and get our new products to the market.

**Similarly, what in the TOMCAT world hasn't changed?**

TOMCAT has always been a customer driven organization from its beginning. We strive everyday to make sure we are providing the best product and service to our customer base. "P/S - Strength under Pressure, it's engineered into everything we do" is our motto that continues to drive us as an organization.

**If you could pick one project from the last 35 years that encompasses TOMCAT what would that be, and why?**

This is a hard question. There have been so many that have helped establish TOMCAT as a market leading manufacturer in this

industry, but one that sticks out to me was "Marvel Universe Live" back in 2014. We worked hand in hand with TAIT and FELD Entertainment to provide all the overhead rigging and scenic structural equipment that was over the show floor. This was Feld's largest production they have produced and was really an engineering marvel when it was all said and done.

**In 2018, TOMCAT opened an office in California to work alongside its flagship Tennessee facility. Can you explain the importance of having both East and West coast offices in the United States?**

I think it's hard sometimes for people to imagine just how big the U.S. is. If we are sending a truck to Las Vegas, for example, it's a week long drive from TN, whereas our CA office can have it there next day, or even the same day! This is a great benefit to our customers and provides them with more options, and obviously, faster, cheaper freight. Being able to offer product on both coasts, along with customer service in all time zones has been a game changer for us, and our customers.

**What do we have to look forward to from TOMCAT in future?**

Things here at TOMCAT are going from strength to strength. We have a great team in place, both internally and externally, our product line is solid and the brand is holding its place in the market. We have already made a commitment to purchase a robotic inventory storage system & plan to invest in some robotic welding machines to help with manufacturing of standard product in the near future.



# TOMCAT USA hosts sold out training

In January '23 TOMCAT's California office hosted a sold out training course 'TOMCAT University'. This was the first time the course was held since 2020, and was sold out with attendees from across the USA and Canada. Day one of the course was taught by our own Adrian Forbes-Black and Keith Bohn and focused on truss education, day 2 was all about engineering and was taught by Jeff Reder of Clark Reder Engineering. Days 3-5 were taught by industry rigging legend, Bill Sapsis. Attendees were treated to Kart racing, axe throwing and daily lunches and a couple of dinners to ensure there was plenty of time for networking and building new relationships! TOMCAT are currently planning a series of one day trainings at their Thousand Oaks location including topics such as 'Truss Inspection', 'Truss 101' and 'Understanding load tables, deflection & basic load math', with TOMCAT University returning in 2024.

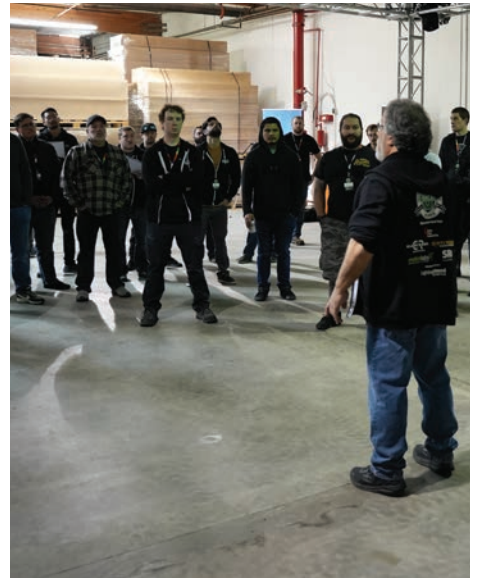

# Roudnice, Czechia. Knoxville, Tennessee. What Do Have These Two Distant Cities in Common?

**They have much more in common than meets the eye. Not only that the two cities, more than 7,500 kilometres apart as the crow flies, are home to Area4Industries' manufacturing plants — Milos Structural Systems in Roudnice and TomCat in Knoxville. Both cities are also located in areas known for a completely different industry, but one that, like stage rigging, brings people joy and fun.**

**Text by Radek Kovanda • Photo by jackdaniels.com, wikimedia, Knox Whiskey Works, Radek Kovanda**

Roudnice nad Labem is located in the southern part of the historical area called the Garden of Bohemia. The area is famous for growing a wide variety of fruits, especially apples, pears and cherries, but also grapes, which are mainly used to produce wine, but not only that. The fruit is not primarily harvested for direct consumption or processed into marmalades, jams or sweet dessert fillings — much of the harvest, which is difficult to store for long periods, is converted into liquid form, fruit brandy. But the Bohemian garden is only a sliver in a larger mosaic of this traditional culture — fruit preservation by distillation is a Central European phenomenon that covers a much wider area, including Bohemia, Moravia, Silesia, Slovakia, Austria, Bavaria and Saxony. You will certainly know these products as 'fruit brandy' — wine, plum, apple, pear, apricot, cherry..., depending on which fruit the brandy is made from. Although, from a purely technical point of view, only wine

brandy is referred to as brandy (made from fermented grape juice), of which Cognac is the world's most famous representative. As a rule of thumb, all Cognac is brandy, but not all brandy is Cognac — it must come only from the region of the same name in France.

Whisky and whiskey are similar cases when the name is concerned. From a purely linguistic point of view, it is just a difference in the spelling of one word referring to a spirit made from fermented corn/malt, then matured in wooden casks. The variant "whisky" is used by the Scots, Canadians and, more recently, by the Japanese, who have come to love the art of making this drink in the last decade. "Whiskey" is in the vocabulary of the Irish and Americans. However, there is also one significant technological difference — while Scotch and other whisky types are distilled twice, Irish whiskey is distilled three times. And, not to be confused, American

whiskey is also distilled only twice, in the same way as Scotch whisky, and has several sub-variants that make it a distinct original drink. They are designated according to which type of grain is primarily used to make it — which is why there are so many different varieties like rye, malt (made of barley), wheat, corn whiskey... and especially bourbon, the most famous representative of which, besides Jack Daniels, are the products of dozens of other distilleries in the state of Tennessee. The latter is the only American bourbon (because real bourbon comes only from the USA) allowed to bear the name Tennessee whiskey.

So just as every cognac is brandy but not every brandy is cognac, every Tennessee whiskey is technologically a bourbon, but not every bourbon is a Tennessee whiskey. What they have in common is that they must be made using a minimum of 51% corn, and they must be aged for a minimum of two years in virgin



oak barrels with charred inner surfaces. What makes Tennessee whiskey so special is the filtration of the primary distillate through a three feet thick layer of maple charcoal — it's called the Lincoln County Process. Ironically, the only whiskey currently produced within the current boundaries of Lincoln County is Prichard's, the only Tennessee whiskey that does not use the Lincoln County Process.

We have taken a long detour from Roudnice to Knoxville, which is not only another Area4Industry base but also one of the key stops on the so-called Whiskey Trail, which knits together 25 local distilleries and gives you a taste of the history, tradition and novelty of Tennessee whiskey. You'll find it right in the heart of Old City at the Knox Whiskey Works distillery. You won't find any official "Czech fruit brandy trail" around Roudnice yet, but just type "distillery" into google maps when zoomed in to this area, and you'll see which

direction to go. Surprisingly, these are distilleries with a much shorter tradition than those in Tennessee, as the boom of "craft distilleries" in Czechia has only recently begun. But they follow the custom of home distilling when every second cottage was bootlegging, same as today's Tennessee distillers have continued a tradition once interrupted by Prohibition.

Of course, we're not enticing you to do any reckless binge drinking — above all, keep in mind that, just like in the USA, the motto "don't drink and drive" (let alone work on stage rigging sets) applies in the Czech Republic, and that the legal drinking age is three years lower here than in America. But the main point is that a bottle of original, honestly made fruit brandy, like honestly made bourbon, i.e. Tennessee whiskey, has an almost unlimited lifespan and can serve as an original souvenir from your travels for your loved ones.

**on the left:**

An old photo from the Jack Daniels distillery in Lynchburg, Tennessee. The distillery is the oldest in the USA and has National Historic Landmark status.

Pallets of sugar maple are doused in raw unaged whiskey before setting the wood ablaze. Cool ashes are then ready to slowly mellow the Tennessee Whiskey.

**in the middle:**

Radlík distillery near Prague, Czechia's capital. Centre of Europe is historically known for its production of beer and fruit spirits. Whiskey production here is only beginning, just as it had in Tennessee centuries ago.

**on the right:**

Even in Knoxville, where TomCat is based, you'll find a regional producer of Tennessee Whiskey.

# Product Highlights

## STKR

The innovative new STKR product (stacker) from TOMCAT, is a simple, yet genius solution to stop damage to your truss, and make truss handling, especially when in storage easier for everyone. It also makes stacking truss quick, efficient, and safe.

- Provides clearance above the floor of the truck/venue to extend truss service life by preventing "road rash"
- Ensures clearance under your truss for a round sling or other items to be passed underneath, so manual lifting is not required
- Aligns truss and prevents vertical truss-to-truss contact & abrasion when stacked on top of each other (without significantly increasing the height of the truss stack)
- Hard wearing UHMW plastic components for durability & long service life
- Fits all standard size truss series'

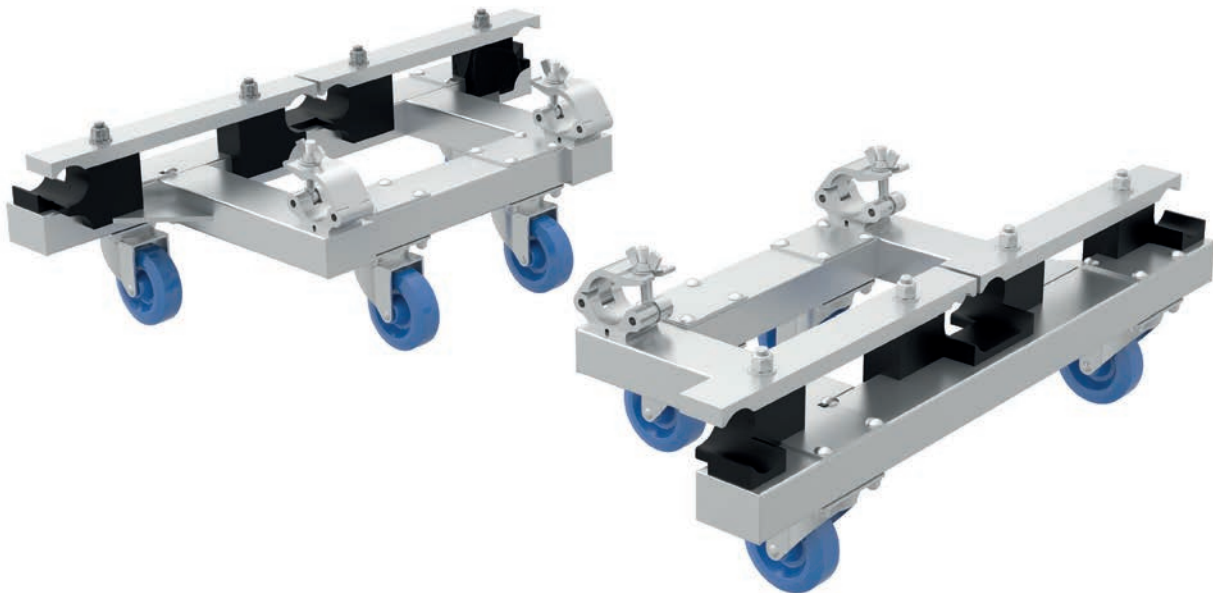
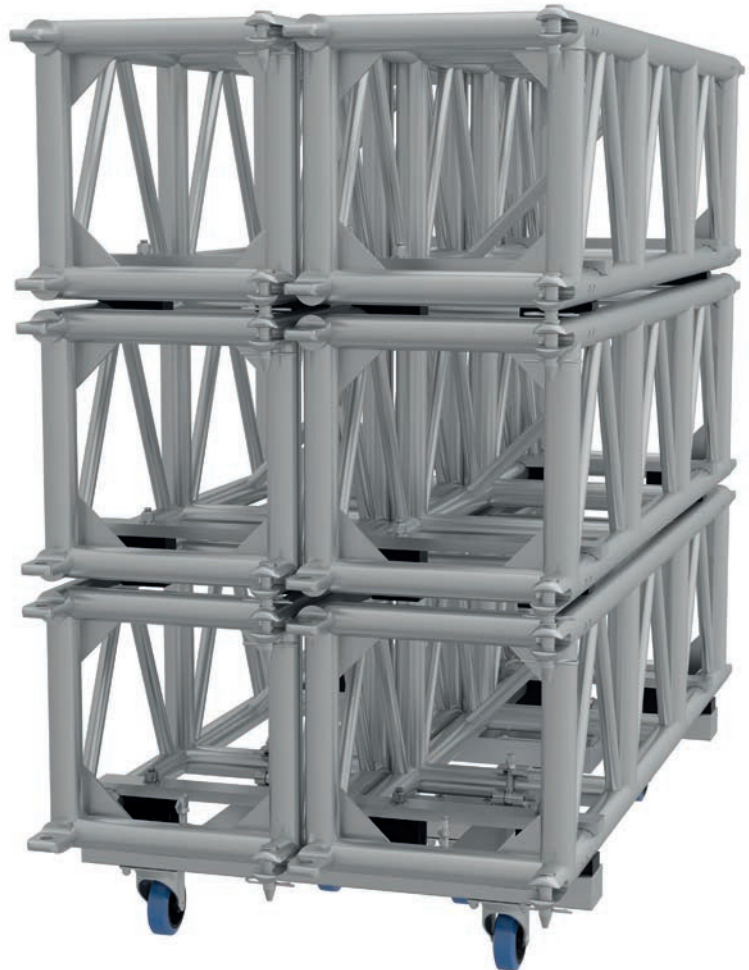

## TOMCAT Ultimate Hinge, angles in creative lighting

Our Light Duty 12 x 12 Ultimate Hinge provides interesting angles for creative lighting setups on your lower capacity support structures. Its hybrid design of aluminum and steel components provides a low self-weight compared to existing load bearing hinges that are often constructed completely from steel.

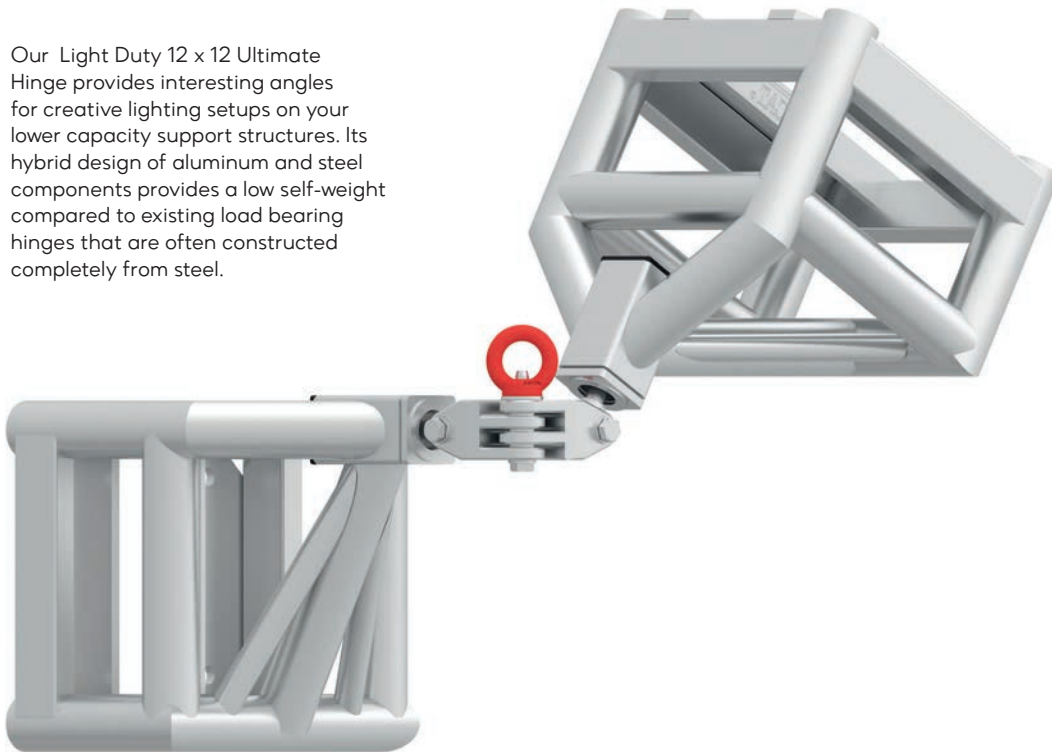

## Flying LED Wall

LED Wall solutions allow users to quickly and easily transition the same LED wall from being used as a vertical wall to a horizontal ceiling using the same components. The wall is assembled on a wheeled cart that can be moved. Integrated rigging points in the framing system allow the wall to be lifted off the carts and used as a flying system.

- Users can assemble an LED wall that can be used in a vertical or horizontal application.
- Rolling Cart allows users to place the LED wall as needed.
- Quick connections to go from vertical to horizontal use.
- Rigging Points included to fly the wall.

# He ran the world's strangest race. Why have only 15 people completed it in 34 years?

Tennessee is not only the home of Tomcat but also a state where you can enlist in a most bizarre, mysterious, physically demanding, and mentally intriguing run race. Everyone has heard something else about it, but most of it is untrue. It's not a race that trumpets its parameters to the world or brags about being the best at something. On the contrary, it keeps everything to itself and lets out as little information as possible. I won't go into all the rumors circulating around Barkley, but I will focus on what I know. Although I attended the race, I can't disclose everything — like how to enter. However, of all the rumors, one thing stands out, one that characterizes it best — very few people have completed this race in its history. In 34 editions (since 1986), it was only 15 runners.

Text and Photo by Pavel Paloncý

## SO WHAT IN FACT DO WE KNOW ABOUT THE RACE?

The course consists of 5 (identical) circuits, only the direction changes. Each one is (supposedly) 20 miles long, so 100 miles in total. The total time limit is 60 hours. In addition, there are incremental limits — 12 hours after the first lap, 24 hours after the second, etc. Whoever misses the time limit drops out.

No gadgets — no GPS, altimeters, pedometers, nothing. Just a classic watch.

On the race route, instead of controls, there are books from which each competitor tears a page straight out of their start number. You don't know the start time ahead of time; you get the 12-hour window and get a notification an hour ahead when Lazarus (the main organizer) lights a cigarette.

The race has no website; signing up is an adventure in itself. Because the race is held in a national park, it is impossible to train directly on the course. Every time someone

finishes the race, Lazarus changes the course (makes it harder).

## A RUN WITH A STORY

When James Earl Ray (Martin Luther King's assassin) escaped from prison in 1977, he was only free for 55 hours before he was caught 8 miles from the prison. The guys were talking about it in the pub, and one of them said: "I could run 100 miles in that time." "You wouldn't," said the other one, and so the legend of the Barkley Marathons was born.

This information is familiar. And it's even true. Well, listen to my story on this year's Barkley Marathons. When I first heard about the Barkley Marathons (BM), it was like "somewhere in the woods of Tennessee, there's this weird race that no one finishes". I wasn't at all attracted to it; from the rumors, it seemed to be a just mischievous romp full of coincidences. But gradually more pieces of the mosaic came to me, I met a few people who had

## From top left to bottom right:

Gary Cantrell, aka Lazarus Lake, supervises (and by lighting his cigarette, gives a start signal to) this most peculiar trail run in the world. It's been years since he's been able to run competitively. He's had a bad back since the eighties, the result of a herniated disk.

Pavel Paloncý, the first Czech man who successfully finished the race in time.

Cantrell hides 13 books along the course. Runners have to tear out the pages corresponding to their bib number to prove they completed the whole loop).

The license plates (hanging in the background) from previous contestants are in fact entry tickets for the run.

This marathon is really of an "ultra" type, up and down over all thinkable types of terrain.

Runners go through day and night, but even if they miss the finish by mere seconds, they are disqualified.

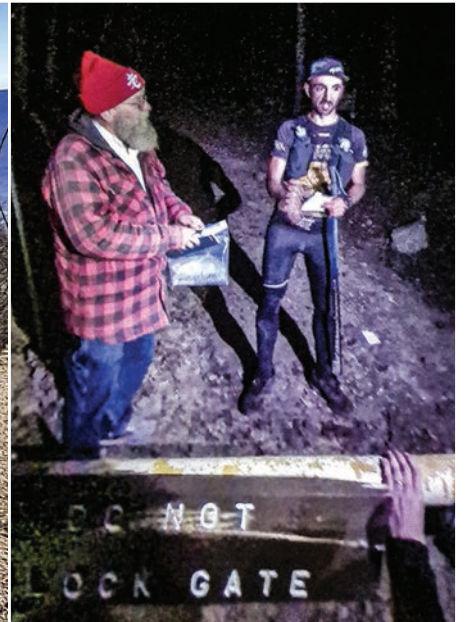

actually run it, and my opinion changed. It still looked like a good dose of mischief, but the element of coincidence was gradually disappearing. I didn't hesitate, went through the sign-ups, and landed at Frozen Head Park, Tennessee, at the end of March. The sleepy campsite in the park did not give the impression that there was a famous race going on. The whole background of the race was provided by a garden tent, around which were hung license plates, which the competitors carry as part of the entry fee. There were vans and caravans all around, but that's normal in the US. Add to that several media crews, photographers, and writers — all for the sake of the 40 racers who came to be tortured by the course.

### THE CALM BEFORE THE STORM

A map of the route was published the afternoon before the start. We also received an itinerary with the length of the sections and the gradient, a verbal description of the route and the traces. At that moment, the race really started for me. The itinerary was full of gradients like +35%, -38%, +18%, +40% and so on. The route description was a five-page litany of how steep the hills were and how the prisoners here suffered when they mined coal. Occasionally jokes and follow-up checks peeked out. The route on the sample map is outlined "sort of" in thick marker. I tried to transcribe all the essential information onto the map, but it was clear that this juggling and linking of different sources of information would be essential in the race.

Although I originally planned to run alone, without support (as usual), I ended up getting support from several people — Nicky Spinks' team and also Juha Lehtonen, with whom I raced in Patagonia. I certainly couldn't complain about the lack of support.

Unlike previous years, we didn't start until around 9 am. The cameramen had been filming Lazarus all night, hoping he would finally light a cigarette and start the race. In the meantime, he was dissecting the local bluegrass. It was bizarre.

Right after the start, we started climbing up a steep hill. At first, still on foot. As the first book (checkpoint) approached, I made the first mistake. Although I kept checking the compass, I didn't turn onto the right ridge. Moreover, the verbal description was a perfect fit here; I didn't even perform the classic terrain adjustment to the map. The only question was "Why the hell am I here alone?". It cost me precious tens of minutes, but I found out that even the compass here is not quite 100%. I caught up with Canadian Morgan McKay at the book, confused out of my wits, but she happily informed me that she had already found the book and to go with her, and she would find me another one. Before I could tear out a page, she disappeared into

the wrong valley, and I haven't seen her since.

But I saw other racers, I started to make my way forward; sometimes the instructions didn't fit, but I found all the other controls quite quickly, read the map properly and moved forward. It was terribly hot in the valleys but cooler and pleasantly windy on the peaks. I was quite baked in the valleys, but I always found water, both for drinking and for making the Edgar drink. With all the things going against you here, it's good to at least have food and drink mastered. I've heard a lot of complaints from others about digestive problems. On the climb to the highest point on the course, I caught up with a group of runners and ran away from them quickly on the run to the prison.

Prison — that's a story too. The control was supposed to be in the tunnel underneath; according to the map, we were supposed to go outside along the wall. But the wall suddenly joined the rock, and it was a four-metre jump down to the prison. Normally I wouldn't have considered it, but given the route the track had taken so far and the descriptions of "if you find it too steep, this is the way to go", I didn't hesitate to climb down the wall. I searched in vain in the prison for the tunnel entrance. So up the wall again, circling the prison until I found the tunnel entrance. Although the prison is no longer in use, I am probably the only person who escaped into prison. Most people break out of prison.

I made it through the next couple of checks until I ran on the trail for a while before the last book and was able to breathe for a while. So I took a breather — I dumped and bumped my knee. I'll run that; I'll run that. And it did for a while. I trotted along the trail; then I momentarily lost consciousness from the pain. Not really knowing what to do next, I lay down for a while, lifted my legs, and then gradually tried to get moving again. I made it to the finish line, but it was clear that the race was over for me. I found all the books, all by myself, my knee wasn't great, but most importantly, I ran 18 minutes past the limit. So much for my personal experience of Barkley.

At the finish line I was congratulated and patted on the back for finding all the books the first time and alone; that was a great performance. Maybe so, but for me, it's mostly a DNF. I only managed one lap and still over the limit. That's to be expected at Barkley — no one completes the race at all at the first attempt, but it's still a "fail". In terms of everything else (like future races), I see a lot of positives there.

Since my first attendance in 2019, Barkley has become something of an obsession for me. I have returned to the race twice more since then. First in 2021, during the coronavirus travel restrictions. It was not possible to travel directly from the EU to the US. So I made a two-week "stopover" in Ecuador and was

the only European at Barkley that year. I completed the second round after the time limit.

This year, I had already targeted my preparation for Barkley and had been training specifically for it since November. I ran/walked up the slope in Kouty nad Desnou, sometimes 7 times in one training session. While the slope has the same elevation gain as the hills at Frozen Head Park, it is not very steep in comparison. I flew to the US a week earlier and spent a few days on the trails at Frozen Head. This year's conditions were good - no rain or fog, but it was very cold, with temperatures dropping to minus 10 at night. That suits me fine, but even this year I didn't avoid trouble in the race itself (that's what the Barkley Marathon is all about, after all), but I completed three laps in 36:32, finishing the 100km, the so-called Fun Run.

### SO WHAT THE HELL IS SO HARD ABOUT THIS RACE?

You can't be blamed for asking this question. I was also expecting to discover one catch, to say, "Oh, that's why". There isn't a single catch. There are more of them:

You're constantly under pressure. You don't have a moment to breathe. You're either scrambling up a 30 per cent hill (mostly loose terrain) or hopping down an equally steep slope. All this in a deciduous forest full of fallen trees, rocks, coal, leaves, and sometimes brambles. You have to constantly watch the map, read the itinerary, look at the descriptions, and look underfoot. I've mastered this. Ironically, when I ran out onto the trail for a while, I lost my concentration and fell.

The route description and map are ancient and completely inadequate. But you'll find that out on the spot, and it's worth the time. And time is exactly what you don't have.

The navigation itself is very challenging, but not impossible. Mostly though, due to the



**You're constantly under pressure. You don't have a moment to breathe. You're either scrambling up a steep hill or hopping down an equally steep slope. All this in a forest with fallen trees, rocks, leaves, and sometimes brambles. You must constantly and simultaneously read the map and the itinerary, look at the descriptions, and watch out for what's underfoot.**

sheer physical demands of the route, there is no time for any navigation at all. You have to know exactly where to run and where the books are. Add to that the lack of information (i.e. the impossibility of specific training) and the inability to train directly on the race course and it's obvious why Barkley is so hostile to newcomers.

Frozen Head Park has a very special microclimate. The whole place is between 500 and 1100m above sea level, so the hills are not even longer; you keep pendulating up and down. It's very hot in the valley during the day but pleasant up there. But it cools down quickly, at night it was around 5°C in the valleys, and on the peaks it was blowing blizzard and snowing. You just don't bring polar gear when you're sweating like a breeding pig.

#### **MAN VS. WILDERNESS**

Add to that the onset of fatigue, and little sleep the night before the race (usually starts in the morning), and you have a recipe for a brutal challenge. Still, this race has its own charm and unmistakable atmosphere.

No one encourages, admires or cheers the runners before the race from the organizers. When you mention that you are running, they usually say, "I am sorry." Oh yeah, with a historical one per cent completion rate, being sorry is a safe bet.

If bad weather comes in another race, it doesn't matter. As long as you handle it better, or at least as well as our opponents, all is well. Whereas at Barkley you're not racing against others, here you're racing against the course and the time. And you're certainly not going to do better than the time; it doesn't matter. As Lazarus said, "Man vs Wilderness."

All of those individual things go against you, but 15 finishers are proof that it's possible, and that creates the urge to try. Challenge accepted.

## **MORE RUNNING MADNESSES**

### **A STORY SIX TIMES LONGER**

#### **Spartathlon (Athens, Greece)**

When Pheidippides ran from Marathon to Athens (42km) after winning the battle, he is said to have said, "We have won", and died. To commemorate that, the marathon is run today. But the story was probably made up by later writers. Herodotus, who lived in the 5th century BC, not long after the Battle of Marathon, does not mention any running but writes that Pheidippides ran from Athens to Sparta (150 miles) to ask for help against Persians. This inspired the Spartathlon run today.

#### **Munga Trail (Belfast, South Africa)**

The extreme difficulty of the course is due to the variable terrain and the altitude of around 7,000 feet m, as well as the distance: over 200 miles to be covered in 120 hours. However, it is possible to indulge in five stops along the way. For those who prefer to ride, there is also the Munga mountain bike race. Five days, 625 miles.

### **THE DEVIL IN THE MOUNTAINS**

#### **Tor des Géants (Aosta, Italy)**

A cross-country race over 205 miles. This race has no stages, and everyone has to decide if and how long to eat, sleep or run. The winner is the one who best distributes his/her forces. Only about half of the starters finish each year.

### **THE COUPLE RACE**

#### **Beskids Seven (Trinec - Frenštát pod Radhoštěm, Czech Republic)**

Compared to the Alps, running the Beskids would seem to be a piece of cake. It takes much time, a total of 29 hours, the route only goes over seven peaks, and you climb around 15,000 vertical feet. And it's mainly a pairs race. Try it out for yourself; the next date is September 1-3, 2023. You may find that even in the Beskids all hell can break loose and that the saying "it's better in two" can be misleading.

### **WINTER ROMANCE**

#### **6633 Arctic Ultra (Yukon, Canada)**

You can choose your route: either 310 miles or just a leisurely 100 mile. Once every two years, you can have a good time and run 440 miles. Temperatures are over 40°C. But below zero! On the sledge, you carry survival items like a cooker, food, sleeping bag and bivy sack. You're travelling alone, and there's no one waiting for you at the finish line.

### **SUN, SAND, WARMTH**

#### **Marathon de Sables (Sahara Desert, Morocco)**

This race suits those who like to ride "in the heat" and like sand. You run a total of 150 miles in four stages and carry everything in your backpack for the whole race. You will get water at the refreshment station. If you don't get lost...

The longest official ultramarathon since 1996 is the Self-Transcendence 3100 Mile Race, where participants run an average of nearly 3,100 miles for 52 days in a row.

#### **Badwater ultramarathon**

Badwater's roots date back to the 1970s, making it one of the grandfathers of modern ultra madness. However, age hasn't diminished its difficulty and it's still one of the toughest running races in the world. Not only is it 135 miles long and the course winds through Death Valley, the hottest place in the United States, but it takes place in July, the month when temperatures reach their peak.

# Safe Precise Certified



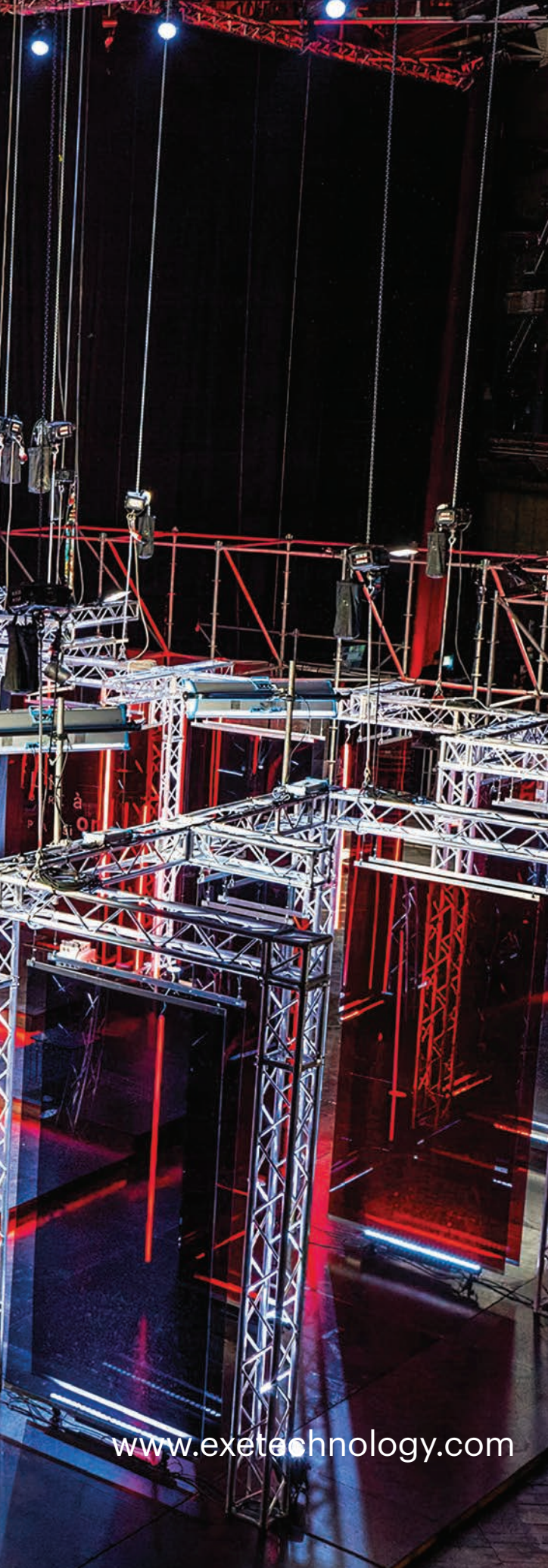

# Unstoppable Evolution

## The Remarkable growth of EXE in the first decade of its life

To date, several thousand units are sold each year, with an ambitious growth plan for the coming years, including the expansion of the production area and the constant development of the Controller range.

In just a few years, EXE has built an excellent reputation in the very competitive hoist market.

This success is due to the design of its robust body, which is made from precision, die cast metal that is relatively lightweight and well-equipped for the tough touring life.

It remains focused on its philosophy of "Safe. Precise. Certified.", which defines and guides its activities.

An electric hoist series with a built-in load cell unit was introduced in 2017 that set the bar for the hoist industry.

Since that time, EXE has remained at the forefront of the electric hoist industry. The Italian EXE factories are constantly pushing the limits of lifting, moving and turning innovations.

Robust, Modern and accurate are the main words that identify EXE Technology - Always prepared for life on the road.

EXE TECHNOLOGY provides customized products and solutions that are designed to meet the specific needs of their customers. These solutions enable the safe handling of various equipment before, during, and after events, regardless of their complexity.

- **Manoeuvre stage equipment**
- **Move, Rotate & Lift**
- **Fixed and Variable speed**
- **Italian design**
- **Certified products**

# EXE Technology is recognized as a leading provider of equipment designed specifically for the entertainment and exhibition industries.



**Raffaella  
Giampaglia**  
EXE TECHNOLOGY  
Brand Manager

## **First, can you tell us briefly when did you start working for EXE Technology?**

I am delighted to share that I have been lucky to work for EXE Technology since 2016. Over the course of my employment, I have encountered great challenges and learned the „secrets“ of our industry. Now I am pleased to say that I have also achieved important milestones and contributed to the growth of the company.

## **Can you tell us a little about the Brand for the people who may not be familiar with it?**

The EXE Technology brand is recognized as a leading provider of equipment designed specifically for the entertainment and exhibition industries. Our product range includes a diverse selection of machinery, all engineered to safely manoeuvre stage equipment, scenery, video walls, and other related structures. From chain hoists and motor controllers to stage tracks and trolleys, our solutions are designed to meet the unique challenges of live events, theatre productions, trade shows, and exhibitions.

## **What do you think makes the brand unique?**

At EXE, we understand the importance of safety when it comes to moving heavy and valuable equipment. That’s why all our products are engineered to the highest safety standards, ensuring that your equipment and performers remain safe at all times. Our equipment is built to last, utilizing the latest technologies and materials to provide superior performance and durability.

In addition to our extensive product range, we also offer exceptional customer support and training programs to ensure that your staff is fully equipped to operate our machinery safely and efficiently.

## **Can you tell us which product do you consider the most interesting?**

The „ONE FOR ALL“ family include electric chain hoists, one of the key products that EXE Technology offers. They are designed to manage heavy loads and offer excellent reliability and durability. Another impor-

tant product family is the motor controllers, highly advanced products that are designed to provide precise control over chain hoists. Load cells are another key product offered by EXE Technology. They are highly sensitive and accurate devices that are used to measure and monitor weight. The horizontal and rotational handling equipment offered by EXE Technology is also highly sought after.

## **What has been the biggest challenge for the EXE Technology in the past year 2022?**

In 2022, EXE Technology faced a significant challenge in the form of creating two major product families. The first, „ONE FOR ALL,“ consists of standalone products that can be used independently of each other. The second, „ALL IN ONE,“ is made up of integrated systems of standalone products that work seamlessly together.

## **What is the current trend in the entertainment industry? Are customer needs and requirements changing?**

The entertainment industry is constantly evolving, and as a result, customer needs and demands are changing as well. Currently, one of the most significant trends is the increase in scenic movement during events, which requires greater attention to safety.

EXE Technology is working to provide innovative safety solutions, such as load cells, which help monitor weight distribution and prevent overloading of equipment.

## **The growing popularity of EXE Technology products is impossible to ignore, with everyone in the industry speaking about them. What are the reasons for their increasing success?**

EXE Technology is one of the leading companies in the heavy load handling and entertainment safety industry.

First and foremost, EXE Technology products are known for their reliability and high-level performance. Over the years, the entire world has become aware of the quality of their products, recognizing their value and excellence.



We believe that one of the keys to success is the integration between chain hoists and controllers. In the past, it was enough to build a good hoist. Now, we need to think about an integrated ecosystem with control devices. After all, users already integrate these tools, we only want to simplify their work. Finally, our ability to customize products based on customer requirements is another factor contributing to the company's great success.

**Can you describe a classic EXE Technology Customer?**

EXE Technology has a diverse and extensive client base that includes distributors located in various countries around the world, as well as end customers and rental companies. Our customer is always a professional who seeks reliable products, support, and often, customized solutions. There is no standard or ideal customer: each customer is unique, and we work to make him feel special.

**Can you describe any interesting project that EXE Technology recently worked on?**

The project recently completed by EXE Technology for a large international client has been an incredible success. The goal was to create a customized chain hoist capable of lifting 2500kg at variable speeds up to 12m/min, with a chain run reaching 80 meters in a single pull and meeting the requirements to be classified UC4 according to EN17206. Thanks to the collaboration between the client's technicians, the competent team at EXE Technology, and one of the most important engineering companies in Italy, we were able to complete this project in just two years, from the ideation phase to the creation of the first prototype and achieve an unprecedented result. Production of over 80 of these chain hoists began in early 2023 and the result has been simply exceptional. We are proud to have been part of this project and look forward to working on equally challenging and rewarding projects in the future.

**What are the plans for EXE Technology this year and beyond?**

EXE Technology is gearing up for a year of great projects and challenges, focusing on growth and technological innovation. The company is currently engaged in a series of investments to increase production and improve the quality of its products. One of EXE's main objectives for this year is to develop a new system called EXE X, which belongs to the „ALL FOR ONE“ family. It consists of a chain hoist and a motor controller, which will allow loads of up to 2000 kg to be moved at variable speeds and with position and weight control devices, as well as emergency and limit switch functions, up to 96 hoists even over long distances. This new system will be able to guarantee greater precision and safety in lifting and moving operations, thanks to the use of cutting-edge technologies of our engineers and the skills of our technical staff.



# Friction, or No Friction, That Is the Question

**In stage rigging, friction is often seen as something that needs to be suppressed or eliminated as much as possible because it causes unwanted wear and degradation of materials. However, this force, ubiquitous in the physical world, takes many different forms. Without friction, it would be virtually impossible to lift loads with a pulley or even to grasp a rope in hand and pull it, let alone walk on foot to a pulley on a slightly inclined but not perfectly level stage.**

Text by Radek Kovanda • Photo by Wikimedia

According to the definition, which you probably remember from your elementary school physics classes, friction is the force acting in the contact area between two bodies. But the surfaces of the two bodies are not touching at all. At the atomic level, there is no perfectly smooth surface; rather it is something like an irregularly constructed planer or a jagged mountain range. And most importantly, from the perspective of both the classical model of the atom and more advanced theories of particle or quantum physics, solid matter is largely made up of space in which different particles or quanta of energy are spaced apart, much like the Sun is spaced apart from the planets of the Solar System. Friction in this context can be imagined as two bodies whose surfaces are made up of steep peaks and valleys formed by miniature

solar systems approaching each other at some critical distance - and without actually physically rubbing against each other, they exert mutually repulsive electromagnetic forces on each other at a distance.

It is because of these forces that they sometimes jam into each other in a deadlock, where opposing forces hold each other in check — in this case, we are talking about so-called static friction. At other times, however, the speed of motion of one of the bodies exceeds the force limit to the extent that the atomic structures of the two surfaces begin to physically change, destroy and break away, in which case we speak of shear friction. It results not only in material damage (for example, when tyres are rubbed off when driving on the road) but mainly in the

generation of heat due to the conversion of kinetic energy into thermal energy (try rubbing your palms together, the heat generated is the result of physical friction).

In everyday life, static (resting) and kinetic (shear) friction often occur "hand in hand". Regularly, there are situations where one body has a certain kinetic energy, thanks to which it gets to (or even beyond) the edge of static friction and goes into shear friction. Still, simultaneously, it expends its original energy, stops, and again finds itself in the static friction phase. A typical example of this is ordinary walking, where the surface of your sole exerts a force on the surface you are walking on, sometimes to the point where your foot slides slightly backwards but loses energy and stops again. Incidentally, this is why icy

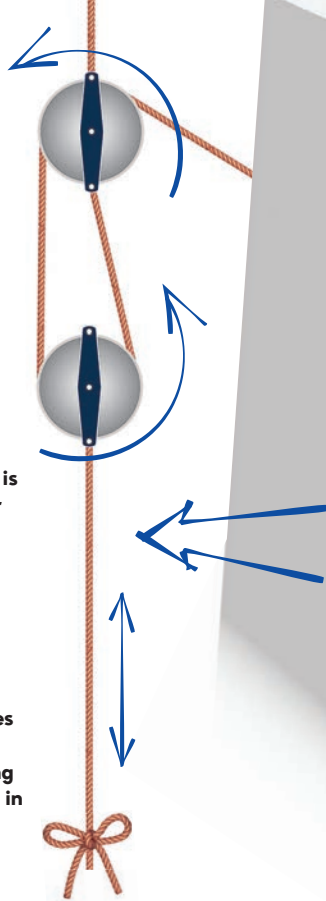

**left:**  
The bow drill, which is a direct predecessor of the lathe, is the first machine ever utilizing both static friction forces (for rotary movement of a bronze pin with a hemp rope) and kinetic friction forces for woodworking, typically shipbuilding or furniture making in ancient Egypt.

**Friction forces are used in the stage rigging industry in various ways. Here are a few examples:**

**Counterweight rigging systems:** Counterweight rigging systems are commonly used in theaters to raise and lower stage scenery. These systems rely on the friction between the hoist line and the sheave (pulley) to control the speed at which the scenery is raised or lowered. By adjusting the tension on the hoist line, riggers can increase or decrease the friction, affecting the speed at which the scenery moves.

**Brakes:** Brakes are used in stage rigging systems to prevent loads from moving too quickly or to hold them in place. Friction is used to slow down or stop the movement of the load. For example, a winch with a friction brake can be used to lower a heavy object slowly and safely.

**Fly systems:** Fly systems are used to lift and lower stage equipment, such as lighting fixtures and scenery, above the stage. The system uses ropes, cables, and pulleys to lift the equipment, and the friction between the ropes/cables and the pulleys is used to control the speed of the lift. The friction can be adjusted to ensure the equipment moves smoothly and safely.

**Tensioning:** Tensioning systems are used to maintain tension in stage rigging lines, such as those used for backdrops and curtains. Friction creates resistance in the line, which keeps it taut and prevents sagging.

Overall, friction forces are critical in ensuring the safety and smooth operation of stage rigging systems. Rigging professionals must have a thorough understanding of friction and how to adjust it to achieve the desired outcome.



**Friction forces in everyday life.**

- Walking:** The friction between your shoes and the ground helps you to walk or run.
- Writing:** The friction between the pen or pencil and paper allows you to write or draw.
- Driving:** Friction between the tires and the road surface allows a car to move and stop.
- Cooking:** Friction between the pot or pan and the stove allows for heat transfer to cook food.
- Brakes:** Friction between the brake pads and the wheels of a car or bike allows you to stop.
- Gripping:** Friction between your hands and objects allows you to grip and hold things.
- Scrubbing:** Friction between a cleaning brush and a surface helps to remove dirt and stains.
- Playing sports:** Friction between sports equipment and the playing surface allows for control and movement.
- Sliding:** Friction between objects and surfaces can cause them to slow down or stop, such as a sledge on snow or a skateboard on the pavement.
- Air resistance:** Friction between objects and air can slow them down or create the drag, such as the resistance felt when riding a bike into a headwind.

pavements are gritted in winter to increase the friction surface. Or when you grab a rope in your hand and pull, it will slip through at one point, but more palm pressure or even just accelerating the movement will stop it.

This is all made possible by a physical force called friction. And not only that. It's what allows vehicles to accelerate and decelerate (brake discs are essentially devices that control the transition between static and shear frictional forces). It's not just cars and trains but also planes, where air friction against the wings and fuselage plays a significant role alongside the force of lift. Also, without friction, nails in the wall would not stick, knots would unravel, furniture placed on the floor would move in the direction you intended at the slightest touch, and you could not draw or write (because you would not be able to hold a writing utensil in your hand, but also the refill from it could not stick to the paper). You could not even operate a mobile phone by swiping. And brushing your teeth every day would become a completely pointless affair.

You also couldn't appreciate some of the basic rigger features like adjustable base feet with rubber pads for optimal friction when building stages, nor could you get swept away by the naturally generated sound waves of stringed instruments, which work on the principle of the Stick-Slip effect, the aforementioned special but the very common case where the combination of static and dynamic friction produce different side effects — in this case, besides the negligible thermal effect, a rather significant sound effect.

The flexible, dynamic, and customer-oriented approach has driven EXE TECHNOLOGY, after a decade of experience, to classify its extensive portfolio of products and solutions into 2 main families:



## ONE FOR ALL SOLUTIONS

Standalone products and solutions designed with the ability to interact and integrate with other electrically compatible technologies, aimed at making the world of stage movement more inclusive and accessible to everyone.

- **CHAIN HOISTS**

Electric chain hoists of any capacity and with any chain length, fixed or variable speed, adaptable to any type of power supply, with or without position control function, and much more. Handle hoists are also available.



- **CONTROLLERS**

Controllers from 2 to 24 channels, linkable or standalone, for direct or low-voltage control, with or without remote control pendant, and numerous additional features.



- **LOAD CELL**

Load cells integrated in the hoist or external, with wireless or wired connection, with or without display, and much more.



- **DYNAMIC STACK TRACK**

Where horizontal movement and rotation are required, EXE Technology offers a wide range of solutions ready to meet any demand

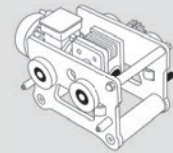

## ALL FOR ONE

products and technologies that combine multiple distinctive functions into a single, integrated, and comprehensive solution, aimed at reducing the need to purchase and use multiple devices or technologies separately.

- Make the installation easy and conquer your decision fatigue by coming to just one resolution.
- Each All-In-One closed system is self-sustaining and includes the ability to create hoist groupings, linkable touchscreen controllers, multi-channel touchscreen remotes, and sensors and devices built into the body of each chain hoist that can modify the performance of each chain hoists and its dedicated controller.
- The All-In-One World includes the EXE B, D, S, E, and K rigging systems.

## EXE TECHNOLOGY NEW WEBSITE!

We are delighted to offer a completely revamped and improved online platform designed to provide the best possible experience for our users. Our new website features a range of new features, including an intuitive and easy-to-use navigation, modern and eye-catching graphics, and a wide range of products and services that cover all your needs.





## DOUBLE REEVE ADAPTOR

**SPECIAL ACCESSORY: for CHAIN from 5mm to 6.3mm**

The accessory used to return the 5x15mm and 6x18mm chain on single reeve hoists which allows you to double the capacity of the chain hoist, halving the speed.

Also called return pulley mounted on a fixed or mobile support according to the needs of the application, and is a mechanical component consisting of a rotating wheel on which the chain is made to slide.



Simple to assemble, easy to transport and compatible with all EXE technology medium frame and medium frame compact hoists:

MEDIUM FRAME COMPACT	<b>EXE</b> ACE	EXE ACE D8 500KG		EXE RISE D8+ 250KG	
MEDIUM FRAME		EXE ACE D8 1000KG		<b>EXE</b> RISE	EXE RISE D8+ 500KG



**EXE Sense 8U**



**EXE Sense 6U**

Our touch screen controller is precision at your fingertips. Control EXE Rise hoists through the digital touchscreen of the EXE Sense, the latest linkable hoist controller by EXE

Technology. Command up to 64 hoists individually or in groupings by connecting linkable 8-channel EXE Sense units. Use the touchscreen to either manually jog into position or input the exact target. Alternatively, control hoists with the multi-channel touchscreen remote.

	FRONT	OUTPUT		FRONT	OUTPUT
<b>8U</b>			<b>6U</b>		<b>CEE</b> 
					<b>CEE+SOCAPEX</b> 
					<b>CEE+HARTING</b> 



**ALL FOR ONE** offers integrated solutions that combine multiple functions into a single system, reducing the need for separate devices. The All-For-One closed system is self-sustaining and includes hoist groupings, linkable touchscreen controllers, multi-channel touchscreen remotes, and sensors and devices built into the body of each chain hoist. These features allow for easy installation and modification of performance for each chain hoist and its dedicated controller. The All-For-One World includes the EXE B, D, S, E, and K rigging systems.

	 <b>DUAL SPEED</b>			
LINKABLE				
TOUCH SCREEN				
GROUP CONTROL				
ENCODER				
LOAD CELL				
REMOTE CONTROL				
SPEED				
HARD LIMIT SWITCH	On request	On request	2 position	4 position
SOFT LIMIT	No	UP & DOWN	UP & DOWN	UP & DOWN



# Brave New World of Robots

The first two welding robots appeared in the Milos factory. They won't replace humans, but they will make their work easier. Many scientists and writers of sci-fi predicted that man would create automatic machines and that these would relieve him of manual toil and, eventually, mental toil. But this will eventually lead to their rebellion, in which they, as a more robust species, will replace humanity. Today, robots already dominate much of industry, both in terms of physical and mental labour, but their apocalypse of rebellion is nowhere in sight. On the contrary, they make our lives easier, and they protect nature.

Text by Radek Kovanda • Photo by Wikimedia

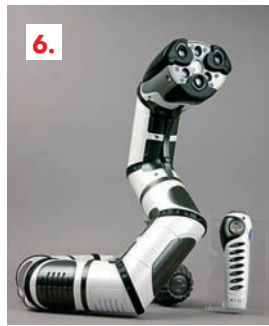
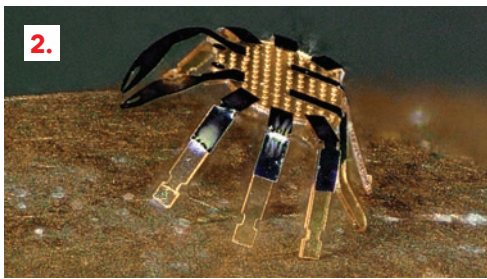

People have always dreamed of robots as artificial machines. The first robot in today's sense of the word (this word was coined in the 1920s in Czechoslovakia and used by the writer Karel Čapek) was the Egyptian Water Clock, built around 1500 BCE. The remarkable thing was not the use of water to tell time but the water force in the clock striking the bells on the hour with the help of human figurines. In 400 B.C., Greek mathematician Archytas invented a flying pigeon — a mechanical bird propelled by steam. In 1495, Leonardo da Vinci designed what we now call the "Robot Knight". This robot not just could sit and stand but also move its arms with the help of pulleys and cables.

For a long time, the production of these "automatons" based on a set of toothed "watch" mechanisms served only for entertainment. It was only the first machine looms that brought the threat to employment and the first revolts against their introduction. In the end, it turned out that the fears of the time were exaggerated. On the contrary, robotisation brought an increase in the productivity of work and its safety and a reduction in production costs. As a result, today, a far greater number of people can afford to buy things that our ancestors often had to save up for years to buy. There has been no collapse of the labour market because automated robots will always need humans to operate and function

properly, just differently skilled than before. Robots have branched out into many areas over the past decade. Cartesian robots working on three linear axes that are mainly used in CCN machines and 3D printing applications. Articulated robots with rotary joints bear a resemblance in functioning to a human arm. They have applications in arc welding, machine tending, assembly, packaging, and material handling. Cylindrical Robots with prismatic joints to fasten the links and a rotary joint at the base are used in the coating processes. Polar (spherical) robots possessing one linear joint and two rotary joints attached to a single arm used in material handling, welding, die casting, and injection moulding. In addition to industrial applications, robots are increasingly being used in completely different fields such as agriculture or research and conservation.

### **1. A Robotic Sloth**

You can see it in action at the Botanical Gardens in Atlanta, Georgia. A slow-moving and energy-efficient robot that can linger in the trees to monitor animals, plants, and the environment below, is being tested near the Garden's popular Canopy Walk. Future plans are to use it to explore natural areas without human disturbance.

### **2. Micro-robot Crab**

It walks like a crab and is as small as a flea. Engineers at Northwestern University are creating the smallest-ever remote-controlled walking robots that can be made to crawl, twist, bend, turn and jump. In the near future, they can act as agents to repair or assemble small structures or machines in industry or as surgical assistants to clear clogged arteries, stop internal bleeding or eliminate cancerous tumors – all in minimally invasive procedures.

### **3. and 4. Fruit Picking Robots**

They pick a wide variety of fruit, from apples and tomatoes to raspberries and strawberries, thanks to their suction arms. Some robots drive like a tractor on the ground, while newer versions take the form of tethered drones. Both types are equipped with miniature cameras that monitor movement in space and the quality of the fruit.

### **5. Pollination Robots**

This picture is just artistic fiction, but pollination robots already exist in reality and look very similar to robotic harvestors. Still, they have different, smaller devices on their ends to transfer pollen from flower to flower.

### **6. Snake Robots**

Robots with articulated mechanisms move like a snake and are planned to be used for the inspection and repair of piping systems.

### **7. Robotic Weed Killers**

Weeding is the most demanding and annoying work in agriculture. But these new robots can recognise even small sprouts of unwanted species and kill them with an electric shock without the need for chemicals.

# Weigh the Moment



# FLEXA Sensors, the Sense of Safety

**FLEXA Sensors is the only brand that offers three load cell management platforms, especially designed for the entertainment industry.**

The Real-Time line is more suitable for managing up to a hundred wireless cells. The system requires a local PC connected to the gateway, and data are updated every second.

The IoT line is suitable for managing large networks with thousands of nodes that connect to the cloud through one or more Gateways.

Data are updated approximately every three minutes, and all information can be accessed by multiple devices connected to the Internet.

The LC-NLP line monitors the loads within a wired safety loop.

The cable connection ensures constant load control and an automatic reaction in case of anomalies.

In the event a glitch occurs, it immediately disconnects the power supply to the hoists.

- **Three platforms for three different needs**
- **Totally innovative design**
- **Sub-1GHz Frequencies (no Wi-Fi interference)**
- **Plug & Play user friendly**
- **Systems ready to scale with new sensors**

# Let's peek into the world of sensors



**Giuliano  
Luvisotto**

**Flexa Sensors Brand Manager**

**First, Gulliano, can you tell us more about your responsibilities at Flexa Sensors?**

Carlo Ughellini and I were the inventors of the FLEXA products and defined the guidelines for the entire project. Now, I'm the Brand Manager, I deal with brand communication and coordinate the development of new products.

**Can you explain to us, how flexa works?**

It is not easy to answer in a few words. I can say that Flexa Sensors is an ecosystem mainly based on wireless devices. Now, with the collaboration of EXE Technology staff, a new platform based on cable connections has been added. The current catalog consists of load cells, but other devices will arrive soon.

**Why have you adopted different frequencies in your wireless platforms compared to other competitors who use the Wi-Fi solution?**

Wi-Fi, like Bluetooth, relies primarily on the 2.4GHz frequency. We adopt frequency bands ranging between 868MHz and 924MHz. They are both valid systems, and each manufacturer chooses its own path. We have opted for a category of frequencies, technically called Sub-1GHz (not exceeding 1 Giga Hertz), it offers a wider range and does not fall within the crowded world of Wi-Fi devices, to avoid potential interference problems with the most common personal devices.

**How can the FLEXA Sensors product be best described and how useful is it on practice?**

Simply, our devices measure the load on many hanging points simultaneously and

make this information available to operators. Knowing the real data on static or dynamic loads is essential for operational safety.

**Which product do you consider to be the most popular?**

In the world of load cells for our industry, the models with shackle cells are the best known. But we are seeing our DynaCell model establishing itself as the best choice for a rigger. The easy of use and the loading accuracy of the DynaCell are superior to any other solution, and I think it will soon be a benchmark product.

**Flexa Sensors combine two worlds together. The LITEC Trussing and EXE Technology rigging motors. How did it all start?**

Simply put: the truss is the structure that supports the event. The hoists lift the equipment. We have added the devices that reads the weight of what is lifted off the ground.

**Are there any new innovations in the company?**

This is a confidential topic. I can only say that our vision is to develop an integrated sensor network. The load cells are just the first step. We are actively working to roll out our platforms with new devices and solutions.

**How does the future look for FLEXA Sensors products? What plans do FLEXA Sensors have for the near future?**

We just want achieve our goal, which is to make FLEXA the world of sensors that generate data for everything needed to set up the event.



# Updates and Improvements



The Shackle Load Cell version has now been updated with solutions that make it much more precise in load reading. We have retained the compactness and distinctive design of our line while improving performance. The accuracy of the load data remains more precise in the DynaCell series due to the design that eliminates all tolerances that, even if minimal, remain in the shackle pin. However, the customer can now choose the system they prefer with a negligible difference in precision.

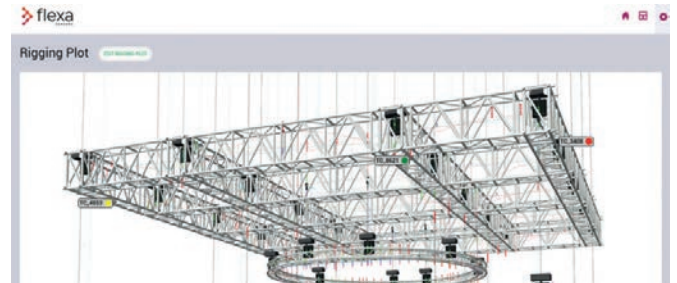

The updated version of the Flexa Control software, implemented in March 2023, allows for the manual placement of cells overlaid on an image, typically a rigging plot, for an immediate view of the cell's position with an indication of the code, load, and load level status.

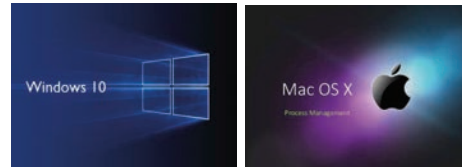

The Flexa Control software is now available for both Windows10 and OSX. The updated software for both operating systems can be downloaded for free from our website [www.flexasensors.com](http://www.flexasensors.com) in the Download area.

# Let's Talk About Frequencies

The distribution of sub-1GHz frequencies in the world

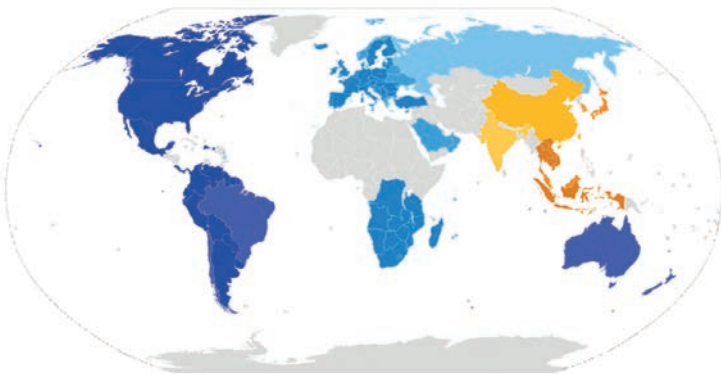

**868MHz, 915MHz, 924MHz**

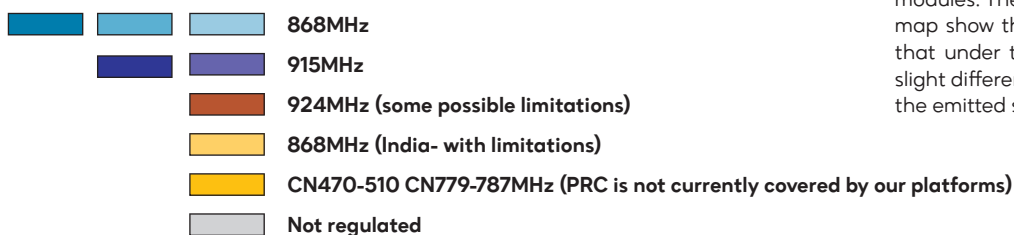

Flexa frequency's platforms are different from any other devices on the wireless load cell market. We have opted for a different choice regarding the transmission frequency between our sensors and their gateways. The frequency commonly used in wireless load cell networks is 2.4GHz, which is used for Wi-Fi and Bluetooth devices. It is a free and unrestricted frequency used worldwide. However, the high concentration of personal devices operating on this frequency can create work overloads with potential connection problems.

Our platform operates on frequencies that belong to the Sub-1GHz category (not exceeding 1GHz) and are regulated differently in various areas of the world. Each of our devices is native with a radio module suitable for the area in which it will operate. Due to technical limitations, it is not possible to use multi-frequency radio modules. The zones marked by the colors on this map show the distribution of frequencies. Note that under the same frequency, there may be slight differences, usually related to the power of the emitted signal.



# Hooked on Shackles

**Did you know that whenever you use hooks for lifting up loads, carabiners to suspend yourself, cell clamps for safe and secure mounting of fixtures, support structure suspension and connections, or even Velcro, you are using an ancient human invention — perhaps the oldest ever, even older than the wheel?**

**Text by Radek Kovanda • Photo by Wikimedia**

The hook as a versatile tool is not, in fact, a human invention but a natural one. Humans, however, have managed to use it to their advantage and for completely different purposes. The oldest artefacts found are fishing hooks from the island of Okinawa, made from twisted snail shells and estimated to be at least 23,000 years old — proving they predate the invention of the wheel by at least ten thousand years. Similarly, hooks naturally grown on bones, antlers or the hardy woody stems of plants were also used. Just as the wheel, originally all-wood, improved over the centuries (it was lightened with spokes and eventually fitted with an inflatable tyre), so did the shape and securing devices on the hooks. And just as the wheel was not only used for transport but also, for example, as a mill wheel or a wheel for pumping water, hooks and their derivatives found a much wider application in the suspension and lifting of heavy loads or the fixing of load-bearing structures. But we had to wait until the 19th century for the invention of solid steel alloys.

**From fish to cranes, from clams to shackles and back to hooks and cell clamps**

Before this happened, a quite different invention — clamps and shackles — had been developing for millennia. The earliest evidence of this is the so-called hose clamps, which were used in ancient Greece as early as 500 BC to join water pipes. They were made of animal skin, but the principle was the same as later metal shackles: U-shaped iron closed with a pin across the jaws. Used for securing things such as halyards to sails, other parts of standing or running rigging where required or anchors to their cables, this invention had been used for quite different than maritime purposes well before Europeans first set sails to explore the New World. Spanish merchants, captains, and adventurers had already conquered and enslaved the people of the Canary Islands in the eastern Atlantic Ocean. On the western coast of continental Africa, the Portuguese had been cultivating a slavery-based economic policy. And it was far from just slaves overseas;

**From the left:**

**A fishing hook looking amazingly similar to its modern counterparts comes from what is now known as Israel and dates back to at least 12 thousand years.**

**A lifting hook made of wood and secured with hemp rope. Dimensions: 17 1/8 x 4 1/16 x 1 11/16 in. (43.5 x 10.3 x 4.3 cm). Dated to 6th – 7th century AC, from Thebes in Egypt.**

**The original principle of the former shackles is the same as that of modern cell clamps: to hold together safely and securely. In the past, this was used for living slaves; today, fortunately, for inanimate structural and bearing elements.**

**Old Romans used elaborate cranes for building massive structures, impressive till today, from aqueducts through temples to entertainment stages like the Coliseum.**



shackles were common in prisons across Europe at the time, not just hand or leg shackles, but neck shackles too. It wasn't until many centuries later that this mechanism for reliably shackling and securing human victims found its wider, more useful and peaceful application in reliably shackling and securing load-bearing elements or loads. But this was, again, as in the case of hooks, only with the invention of steel and light metal alloys and the ultra-precise manufacture of the threads necessary for the locking bolts. It was, therefore, not until the mid-twentieth century that elements such as carabiners, slip hooks, shackles and cell clamps were born. These combine several technological innovations, but their origin was the simple hook in the natural hook-shaped structures, which people adapted to their needs.

#### **From burdock to micro-hooks and loops**

As has already been said, the hook is not a human invention but a natural one. For example, some plants coat the surface of their

seeds with miniature hooks. These trap the seeds in the fur of passing animals, carrying them over much longer distances than if the plant were to rely on the wind alone. This tens of millions of years old natural mechanism was known to naturalists long before it was explored "amateurishly" by a Swiss man called Georges De Mestral, who regularly took walks in an area where grows a plant called burdock. Its seeds are covered with tiny hooks that easily stick to clothing — and got regularly stuck to the thick fur of his dog. After spending many hours removing the burrs from the fur, he decided to explore their peculiar nature under a microscope. He saw small hooks, and as a technician, albeit specialised in electricity, it occurred to him that some use could be made of this unpleasant feature. It took another eight years of experimentation before he could devise microscopic counterparts (loops) to the hooks so that they would fit together perfectly. Thus Velcro was invented, without which no rigger today can imagine a proper assembly belt.



# Flexa Sensors and EXE Technology



It was necessary to combine the wireless load cell lines with a wired connection system. Wired systems have the advantage of being constantly active and allow automatic responses in safety interventions. These devices can be installed anywhere, without the worries of radio coverage and the limitations of battery life.



LC-NLP

The design of **Flexa DynaCell** combined with **EXE LC-NLP** technology based on wired environments is our solution for safe load control. DynaCell are available in 500kg and in 5 tons WLL, with a safety factor of 8:1.

**The Network Load Processor** is the central unit connecting the load cells.

The wired mode, with instant intervention in case of emergency, is the most advanced solution for the safety of loads.

## The Network Load Processor (NLP) Unit

It can control up to 16 cells, each with its own XRL cable, and has the emergency stop output to the controllers. It's a point-to-point star wiring connection. Each unit is connected directly to the NLP so that all other connections can remain active in case of single-cable malfunctions.





# Powder Coating Explained

## The Mystery of Powder Coating Unveiled

MILOS aluminium products of all sizes are, for some time already, available with powder coating. This type of finish has gained considerable popularity recently for its toughness and durability. And since MILOS wants to offer its customers products that are durable, sustainable and good-looking, powder coating is the choice.

Powder coating, as its name suggests, is a form of dry paint free of any solvents. This has several major benefits. As the powder coating does not contain any liquid, thicker coats of paint can be applied compared to conventional liquid coatings. Also, powder coating can be applied horizontally and vertically without any difference in appearance.

The process was invented in mid 20th century. Unlike conventional liquid paint, powder coating is typically applied by an electrostatic paint gun and then cured under heat or ultraviolet light. This makes the process fairly straightforward. The paint is attached to the metal surface by the positive charge. The product is then moved to an infrared oven, where it is heated up so the powder melts into a uniform film. This is followed by a cooling process, resulting in a finish that is significantly tougher than conventional paint, resistant towards scratches, chipping and peeling.

It should be stressed that the powder coating process is environmentally friendly, as powder coatings contain no solvents and release little or no amount of volatile organic compounds into the atmosphere. In addition, any overspray during the coating process is captured and can be reused.

MILOS strives to provide its customers with the most effective, efficient and sustainable solution. Powder coating is a part of these efforts.

# Time to Change the Channel!

The first Trussing & Rigging internet television focused on education, design, rigging, products, and on-site videos.

A4I.TV will be your one stop website for viewing videos produced by Area Four Industries and its truss brands – MILOS, LITEC, James Thomas Engineering, TOMCAT and PROLYTE.

Navigation on the channel's website is very user-friendly. All of its videos are divided

into five categories – Educational, Design Basics, Product Basics, Rigging Basics and On-Site Videos.

Just choose which category interests you, and you'll be presented with a choice of all videos within that category. Alternatively, you can choose one of the group's brands and be presented with all videos related to that brand.

You can look forward to many different

videos and video series that Area Four Industries will be releasing on an on-going basis.

All videos on A4I.TV are created with the goal of showing you something new, passing on valuable knowledge, sharing tips and tricks within the rigging and support structure industry, presenting new and exciting products, and giving you an insider's view of exciting projects carried out by brands within the Area Four Industries group.





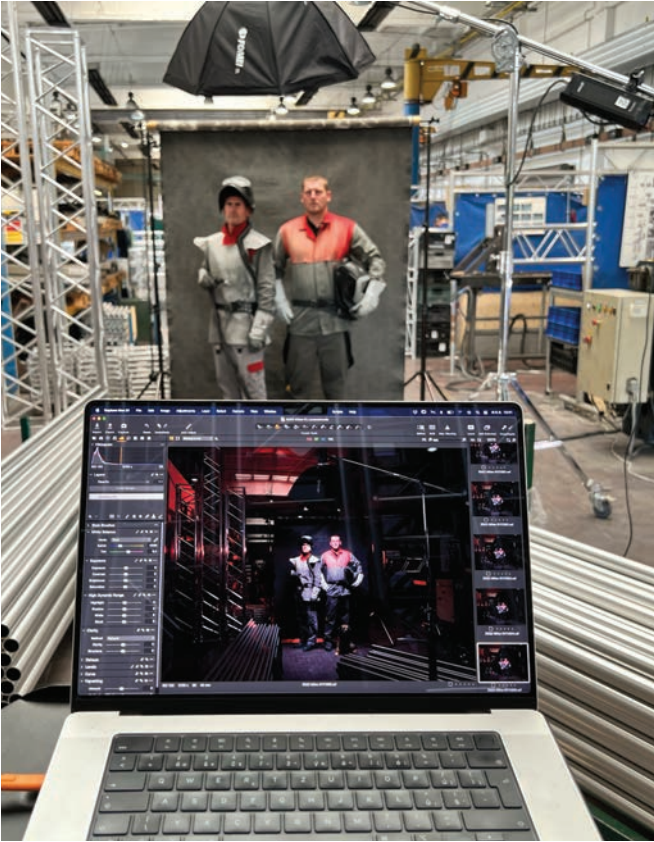









[HOME](#)
[CATEGORIES ▾](#)
[OUR BRANDS ▾](#)
[RIGGING COMMANDOS](#)
[SERIES](#)
[YOUR VIDEOS](#)

[Submit Video](#)

**Categories**

- Design Basics (3)
- Educational (23)
- On-site videos (20)
- Product basics (67)
- Rigging basics (24)
- Uncategorized (2)
- Velvet Backstage (15)
- Your videos (6)

**Commandos**

-  Eric Loanstra  
5 videos
-  David Gore  
2 videos
-  Adam Beaum...  
3 videos
-  Norbert Tripp  
10 videos
-  Eric Porter  
13 videos
-  Will Todd  
2 videos
-  Adrian Forbes...  
1 video

**LATEST TRUSSING & RIGGING VIDEOS**



**Prolyte Robotic Production Lines**  
Worldwide Premiere



Eric Loanstra  
ISU Series



Rigging  
Distributory Meeting 2022



MCCS  
Steel Truss Project



Frankfurt, Germany  
Pralight + Sound 2022

**EDUCATIONAL VIDEOS**



**Arena Chalk Markings**  
(Visited 1232 times, 1 visits today)  
a4i.tv / NOVEMBER 10, 2021



**Technical planning of a video wall (American version)**  
(Visited 580 times, 1 visits today)





**Technical planning of a video wall (EU)**  
(Visited 372 times, 1 visits today)





**PROLYTE - American Webinar**  
(Visited 925 times, 1 visits today)  
a4i.tv / JANUARY 14, 2021

**Recommended Series**

- 

**Basic of Rigging**  
11 Episodes  
MARCH 2, 2022
- 

**Truss Connectors**  
2 Episodes  
AUGUST 20, 2019
- 

**Truss Engineering**  
4 Episodes  
MAY 22, 2019
- 

**Rigging Basics**  
6 Episodes  
NOVEMBER 26, 2018
- 

**Knots Binding**  
4 Episodes  
JUNE 25, 2018

**Velvet Backstage**

# The Deadline Hunter

**In this short interview, we will talk to the person responsible for the team of welders and workers here in the Czech Republic. This team is constantly working on the production of the Highest-Quality Trusses that are well-known worldwide.**



**Pavel Stryhal**  
A4I Production Manager

**First, can you tell us when you started working at Area Four Industries Czech Republic?**

I have been happily with the company since November 2004.

**What are your responsibilities as the Production Manager at Area Four Industries Czech Republic?**

I consider the biggest responsibility in my position to be setting a deadline for order and, most importantly, meeting it.

**Can you describe your typical day at work?**

Each day starts with checking the current production status, followed by the processing of new orders. I also spend a large part of the day processing new order enquiries. Into this comes daily online production or supplier issues that need to be addressed promptly. In this daily cycle, I am assisted by a close circle of close associates, foremen and production assistants.

**What was the biggest challenge for you in the last year, 2022?**

The biggest challenge was to manage the increase in production volume in the company's existing premises.

**Last year was very challenging and fraught with negative impacts, whether it was the energy crisis or increasing fuel prices which led to increasing prices in materials. Have these manifested themselves in the production hall?**

Of course, we have also experienced increased employee sickness or late material de-

liveries, but these problems have been experienced virtually worldwide in the past period.

**Are there any innovations in your production hall that should be mentioned?**

This year we would like to take full advantage of the new vertical warehouses, especially the robotic welding workstations, to increase production output further.

**You are responsible for a large team of welders and workers. What is the usual mood at the production hall?**

Although our staff numbers have grown significantly over the last year, we still manage, with the help of long-term staff and colleagues, to keep the morale or atmosphere high, with the aim of doing the highest quality work for customer satisfaction.

**Your product range certainly includes much more than support trusses; can you tell us more about other products you manufacture here?**

The product range is much broader. In addition to the production of structures, a significant part is the production of podiums and their accessories or the production of barriers, with several variants according to customer requirements.

**What are the goals for the future?**

To continue the existing work so that the customer is satisfied, both with the deadline and quality. The proof for us is the additional orders from current or new customers.



**Distribution offices** 

**United Kingdom**

Unit 5-6 Beechwood Estate Cattle Dyke,  
Gorefield Wisbech Cambridgeshire  
PE13 4NR  
United Kingdom

**America**

**East**

5427 N. National Dr.  
Knoxville TN 37914  
USA

**West**

950 Lawrence Drive, Suite B  
Thousand Oaks,  
CA 91320  
USA

**Germany**

Johann-Krane-Weg 27  
Münster 48149  
Germany

**Italy**

Via Martin Luther King, 70  
31032 Casale sul Sile (TV)  
Italy

**United Arab Emirates- ME**

Office LB15317, Bldg. 15,  
Jebel Ali Free Zone,  
UAE

**Area Four Industries Czech Republic**

Spindlerova 286  
Roudnice nad Labem 413 01  
Czech Republic

**Area Four Industries Italy**

Via Martin Luther King, 70  
31032 Casale sul Sile (TV)  
Italy

**Manufacturers** 

**Area Four Industries Czech Republic**

Spindlerova 286  
Roudnice nad Labem 413 01  
Czech Republic

**Area Four Industries Italy**

Via Martin Luther King, 70  
31032 Casale sul Sile (TV)  
Italy

**Prolyte**

Industriepark 9 9351  
PA Leek,  
The Netherlands

**TOMCAT**

5427 N. National Dr.  
Knoxville TN 37914  
USA

**MILOS**

House No.1-3, 6 Gong-Ye Road, Da-Wen Cun  
Dong-Chong Zhen, Nansha district,  
Guangzhou  
China

